

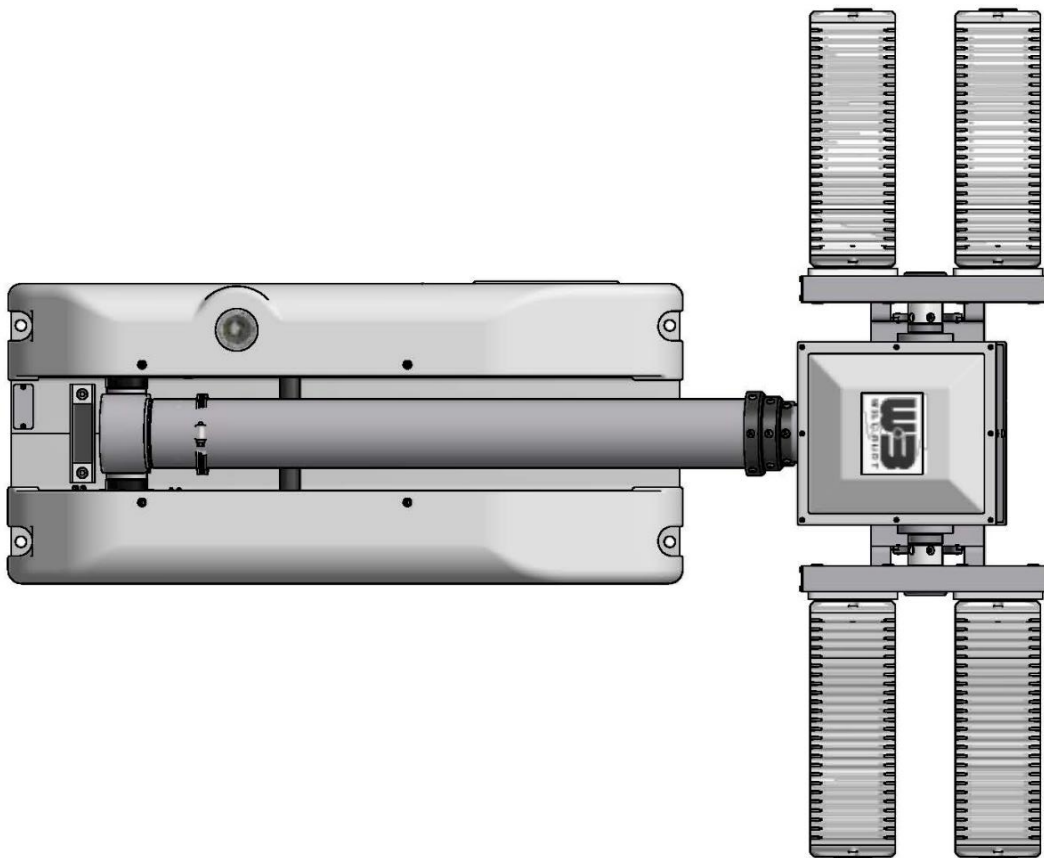

**NIGHT SCAN POWERLITE 2.3 & 1.8
OPERATOR'S MANUAL**

nightscan[®]



The Will-Burt Company
169 S. Main Street
Orrville, OH 44667

www.willburt.com

TP-5096501-H, November 2017
© 2017 The Will-Burt Company

Night Scan[®] Warranty

Will-Burt warrants its Night Scan[®] to be free from defects in material and workmanship for a period of two (2) years, with such time period running from the date of shipment by Will-Burt. Will-Burt shall not be responsible for any damage resulting to or caused by its products by reason of failure to properly install, maintain or store the product; use of the product in a manner inconsistent with its design; unauthorized service, alteration of products, neglect, abuse, accident, or acts of God. This warranty does not extend to any component parts not manufactured by Will-Burt; provided, however, Will-Burt's warranty herein shall not limit any warranties by manufacturers of component parts which extend to the buyer.

THE FOREGOING WARRANTY IS IN LIEU OF ALL OTHER WARRANTIES, AND NO REPRESENTATIONS, GUARANTEES OR WARRANTIES, EXPRESS OR IMPLIED, INCLUDING BUT NOT LIMITED TO, A WARRANTY OF MERCHANTABILITY, FITNESS FOR A PARTICULAR PURPOSE, OR NON-INFRINGEMENT ARE MADE BY WILL-BURT IN CONNECTION WITH THE MANUFACTURE OR SALE OF ITS PRODUCTS. NO EMPLOYEE, DISTRIBUTOR, OR REPRESENTATIVE IS AUTHORIZED TO CHANGE THIS WARRANTY IN ANY WAY OR GRANT ANY OTHER WARRANTY ON BEHALF OF WILL-BURT.

Claims for defects in material and workmanship shall be made in writing to Will-Burt within thirty (30) days of the discovery of defect. Failure to provide notice as required hereby shall be conclusive evidence that the product was in conformity with the warranty, and Will-Burt shall be released from any and all liability relating to the product. Will-Burt may either send a service representative or have the product returned to its factory at Buyer's expense for inspection. If judged by Will-Burt to be defective in material or workmanship, the product will be replaced or repaired at the option of Will-Burt, free from all charges except authorized transportation.

THE REMEDIES OF BUYER SET FORTH HEREIN ARE EXCLUSIVE AND ARE IN LIEU OF ALL OTHER REMEDIES. THE LIABILITY OF WILL-BURT WHETHER IN CONTRACT, TORT, UNDER ANY WARRANTY, OR OTHERWISE, SHALL NOT EXTEND BEYOND ITS OBLIGATION TO REPAIR OR REPLACE, AT ITS OPTION, ANY PRODUCT OR PART FOUND BY WILL-BURT TO BE DEFECTIVE IN MATERIAL OR WORKMANSHIP. WILL-BURT SHALL NOT BE LIABLE FOR COST OF INSTALLATION AND/OR REMOVAL, OR BE RESPONSIBLE FOR DIRECT, INDIRECT, SPECIAL OR CONSEQUENTIAL DAMAGES OF ANY NATURE.

Document History

Document Numbers	Dates	Remarks
TP-5096501-00	March 17, 2015	Initial Release
TP-5096501-A	March 20, 2015	Updated figures in Section 2.8.
TP-5096501-B	September 8, 2015	Updated Section 5.4.
TP-5096501-C	October 13, 2015	Updated Sections 1.5.1.2, 1.5.1.3, 1.5.1.4, 2.8, 2.12, 3.4, 3.5, 3.9.2, and 4.3.
TP-5096501-D	March 4, 2016	General update
TP-5096501-E	June 23, 2016	Update Sections 1.5.3, 2.1, 2.2, 2.5, 2.9, 3.9, 4.3, and 8.
TP-5096501-F	October 18, 2016	Updated Sections 2.3 and 2.8.
TP-5096501-G	November 8, 2016	Updated Section 4.3.1
TP-5096501-H	November 22, 2017	Updated to add NightScan 1.8

Table of Contents

Section 1 Introduction	1-1
1.1 Safety Precautions	1-1
1.2 How this Manual is Organized	1-1
1.3 Additional Documentation	1-2
1.4 The Definition of the Mast Position	1-2
1.5 Major Components	1-3
1.5.1 Base	1-3
1.5.1.1 Mast	1-4
1.5.1.2 Left Side of the Base.....	1-5
1.5.1.3 Right Side of the Base	1-7
1.5.1.4 Saddle	1-8
1.5.2 Remote Controlled Positioner (RCP)	1-8
1.5.3 Lights.....	1-8
1.5.4 Controllers.....	1-9
1.5.4.1 Controller Interface.....	1-10
1.6 Unit Specifications.....	1-10
Section 2 Installation	2-1
2.1 Ensuring That it Fits	2-1
2.1.1 Dimensions	2-1
2.1.2 Mast Loads.....	2-1
2.1.1 Mast Loads.....	2-1
2.2 Get Your Tools	2-2
2.3 Components	2-2
2.4 Unpacking	2-3
2.5 Attaching to the Vehicle	2-3
2.6 Attaching the Controller.....	2-5
2.7 Attaching the Holder.....	2-6
2.8 Wiring the Base Board	2-6
2.8.1 Wiring the Bulkhead Control Cable to the Base Board	2-6
2.8.2 Wiring the DC Power to the Base Board	2-7
2.8.3 Wiring the Lights to the Base Board	2-7
2.9 Connecting the Warning Light/ Interlock Output Contact.....	2-9
2.10 Connecting the Interlock Input Contact.....	2-9
2.11 Testing the Installation	2-10
Section 3 Operation	3-1
3.1 Pre-Operation Check	3-1
3.2 Controllers	3-2
3.3 Quick Summary.....	3-2
3.4 Initiating	3-3
3.5 Raising the Mast to 90°	3-4
3.5.1 Using the Auto-Up Feature	3-5
3.5.2 Using the Mast Up Button	3-5
3.6 Extending the Mast	3-5

3.7 Controlling the Lights	3-6
3.8 Lowering the Mast	3-6
3.9 Stowing the Mast	3-6
3.9.1 Using the Auto Stow® Feature	3-7
3.9.2 Using the Mast Down Button	3-7
3.9.3 Emergency Stow with Power	3-8
3.9.4 Emergency Stow without Power	3-9
Section 4 Maintenance and Adjustments	4-1
4.1 Cleaning the System	4-1
4.2 Functional Test	4-3
4.2.1 Emergency Circuit Test	4-3
4.2.2 Brake Function Test (Standard Only)	4-3
4.2.3 Function Circuit Test	4-3
4.3 Adjusting the 90° and Mast Stowed Switches	4-4
4.3.1 Diagnostic LEDs	4-4
4.3.2 Adjusting the 90° Switch	4-5
4.3.3 Adjusting the Mast Stowed Switch	4-6
4.4 Adjusting the Magnetic Down Switch	4-7
4.5 Adjusting the RCP Home Position	4-7
Section 5 Reference Information	5-1
5.1 DIP Switch Definitions	5-1
5.2 Strobe/Beacon Light	5-1
5.3 Nycoil (Optional)	5-2
5.4 Will-Burt Mast Oil MSDS Sheet	5-3
Section 6 Troubleshooting	6-1
6.1 Troubleshooting Electrical	6-1
6.2 Troubleshooting Mechanical Symptoms	6-6
Section 7 Appendix	7-1
7.1 Installing the PMRC	7-1
7.1.1 Attaching the PMRC	7-1
7.1.2 Wiring the Base Board	7-2
7.1.3 Wiring the PMRC	7-2
7.2 Installing the Wireless HHRC	7-2
7.2.1 Attaching the J-Box	7-2
7.2.2 Attaching the Holder	7-3
7.2.3 Wiring the Base Board	7-3
7.2.4 Wiring the J-Box	7-3
7.2.5 Connecting the Controller	7-4
7.2.5.1 Initializing the Wireless HHRC and J-Box	7-4
7.2.5.2 Charging the Wireless HHRC	7-4
Section 8 Drawings	8-1

Table of Figures

Figure 1-1 Mast Positions	1-2
Figure 1-2 Night Scan Powerlite 2.3 and 1.8 Parts.....	1-3
Figure 1-3 Mast Components.....	1-4
Figure 1-4 Internal Coil Cord.....	1-5
Figure 1-5 Left Side of the Base	1-5
Figure 1-6 Base Board (P/N: 4311701)	1-6
Figure 1-7 Right Side of the Base.....	1-7
Figure 1-8 Dual-Tilt Remote Controlled Positioner (RCP)	1-8
Figure 1-9 Night Scan Powerlite 2.3 and 1.8 Lights	1-8
Figure 1-10 Dual-tilt controller options.....	1-9
Figure 1-11 Bulkhead.....	1-10
Figure 1-12 J-Box.....	1-10
Figure 2-1 Load Distribution.....	2-1
Figure 2-2 Lifting Point on the Powerlite 2.3 and 1.8.....	2-3
Figure 2-3 Mounting Hole Locations	2-4
Figure 2-4 Bulkhead Dimensions	2-5
Figure 2-5 Holder for the Controller	2-6
Figure 2-6 Wiring J4.....	2-6
Figure 2-7 Switches	2-7
Figure 2-8 Light Power Inputs.....	2-8
Figure 2-9 Relay.....	2-9
Figure 3-1 Hex Head Bolt Location.....	3-9
Figure 4-1 Regulator	4-2
Figure 4-2 Diagnostic LEDs D7/D8, D10/D11, and D13/D14	4-5
Figure 4-3 Mast Stowed and 90° Switch.....	4-6
Figure 4-4 Photo Interrupter and Flag.....	4-8
Figure 4-5 RCP Home Position.....	4-9
Figure 5-1 Optional Strobe/Beacon Light.....	5-1
Figure 5-2 Nycoil Cable.....	5-2
Figure 7-1 PMRC Dimensions	7-1
Figure 7-2 J-Box Dimensions.....	7-3

Table of Tables

Table 1-1 Night Scan Powerlite 2.3 and 1.8 Specifications	1-10
Table 2-1 Tools and Materials Recommended for Installation	2-2
Table 2-2 Sample Amp Calculation	2-8
Table 4-1 Mast Positions Shown by Diagnostic LEDs.....	4-4
Table 6-1 Base Codes	6-1
Table 6-2 RCP and Positioner Codes.....	6-4
Table 6-3 HHRC Codes	6-5
Table 6-4 Wireless J-Box and Wireless HHRC Codes	6-6
Table 6-5 Mechanical Symptoms and Troubleshooting Sequence	6-6

Safety Summary

SIGNAL WORD DEFINITION

Per the ANSI Z535.4 standard, the following signal words and definitions are used to indicate hazardous situations:

DANGER

DANGER indicates an imminently hazardous situation that, if not avoided, will result in death or serious injury.

WARNING

WARNING indicates a potentially hazardous situation that, if not avoided, could result in death or serious injury.

CAUTION

CAUTION indicates a potentially hazardous situation that, if not avoided, may result in minor or moderate injury. It is also used to alert against unsafe practices.

NOTES address practices not related to personal injury.

GENERAL SAFETY PRECAUTIONS

The following are general safety precautions that are not related to any specific procedures and therefore do not appear elsewhere in this publication. These are recommended precautions that personnel must understand and apply during many phases of operation and maintenance.

DANGER

Electrocution Hazard! Contact with high voltage will result in death or serious injury. Observe general safety precautions for handling equipment using high voltage. Do not locate or operate mast near electrical lines, cables or other unwanted sources of electricity. Do not operate mast in lightning. Be certain electrical cables are undamaged and properly terminated. Always disconnect power at the breaker box of the unit before performing service, repair, or test operations.

WARNING

Safety Instruction – Read Manual! Failure to follow operating instructions could result in death or serious injury. Read and understand the operator's manual before using the mast.

WARNING

Tip Over Hazard! Mast tip over could result in death or serious injury. Do not operate in high winds. Operate on level ground only. Stand clear of mast and mast payload during operation. Be certain mast is level and secure before and during installation, operation, and maintenance.

⚠ WARNING

Safety Instruction – Trained Personnel Only! Death or serious injury could result if proper inspection, installation, operation, and maintenance procedures are not observed. Installation, operation, and maintenance to be performed by trained and authorized personnel only. Proper eye protection should be worn when servicing the mast.

⚠ WARNING

Health and Safety Hazard! Solvent used to clean parts is potentially dangerous. Avoid inhalation of fumes and also prolonged contact to skin.

⚠ WARNING

Safety Instruction – Do not look at lights! Do not look directly into lights when they are illuminated. Temporary impairment or permanent vision damage could occur.

SPECIFIC SAFETY PRECAUTIONS

The following are safety precautions that relate to specific procedures that may appear elsewhere in this publication for emphasis. These are recommended precautions that personnel must understand and apply during specific phases of installation, operation, and maintenance.

⚠ WARNING

Safety Instruction – Operation! For outdoor use only. Do not use in areas that have been classified as hazardous as defined in Article 500 of the National Electric Code.

⚠ WARNING

Crush Hazard! Death or serious injury could result if mast fails suddenly. Do not stand directly beneath the mast or its payload. Be certain payload is properly installed and secured.

⚠ WARNING

Burst Hazard! Over-pressurizing mast will trip safety valve and could result in death or serious injury. Do not exceed maximum operating pressure of 20 psi (138 kPa) for Standard Duty masts. Keep personnel clear of safety valve exhaust direction.

⚠ WARNING

Fire Hazard! Cleaning solvent, used for maintenance, is flammable and can be explosive resulting in death or serious injury. Do not smoke. Use cleaning solvent in a well-ventilated area. Keep cleaning solvent away from ignition sources. Always store cleaning solvent in the proper marked container.

⚠ WARNING

Relocation Hazard! Relocating the mast during operation or after being raised could result in death or serious injury. Do not relocate the mast during operation or while raised. This applies especially to masts mounted to vehicles. Operate the mast only if the vehicle is stationary and the vehicle engine is off.

⚠ WARNING

Mast Extension Hazard! Extending mast into obstructions could result in death or serious injury and could render the mast inoperable and partially extended. Before applying power and operating the mast, be certain there is sufficient clearance above and to all sides of the expected location of the fully extended mast and payload. Keep all persons clear of mast and mast extension. Do not lean directly over the mast.

⚠ WARNING

Mounting Structure Hazard! Mounting mast into a structure unable to resist the forces generated from customer-specific loading scenario could result in death or serious injury and could damage the mast. Before operation, be certain mounting structure is capable of resisting forces generated from all loading and environmental conditions, including, but not limited to, mast size and weight, payload size and weight, sail size, wind speed, guy line arrangement, support bracket or roof line location, and base plate assembly.

⚠ WARNING

Electrocution Hazard! Do not touch live wires. Death or serious injury could result.

⚠ WARNING

Safety Instruction – Operation! Make sure all power has been disconnected prior performing maintenance.

⚠ WARNING

Safety Instruction – Trained Personnel Only! Only trained and qualified personnel should perform installation, adjustments, and servicing. Only a properly trained and qualified certified electrician should perform electric installations and service.

⚠ WARNING

Safety Instruction – Operation! At all times prior to mast operation, ensure that:

- The mast area is free of personnel and mechanical obstruction;
- All electrical cables are undamaged and properly terminated;
- The operator must have full view of the mast during use;
- Any transit tie-downs on the payload have been removed;
- The vehicle is not moving;
- The area above the mast is free of mechanical obstructions.

⚠ WARNING

When re-lamping an installed fixture, make sure all power to fixture is off and that the fixture is cool.

⚠ WARNING

Make certain that the area is free of overhead power lines and other unwanted sources of electricity. Follow OSHA safety regulations when working near energized power lines. Be sure to allow sufficient clearance on all sides of mast to allow for side-sway.

⚠ WARNING

Do not use in the presence of flammable gases or liquids such as paint, gasoline or solvents. Do not use in areas of limited ventilation or where high ambient temperatures are present. Contact with combustible materials can cause ignition resulting in fire or explosion.

⚠ WARNING

Keep personnel clear of mast while during operation.

⚠ WARNING

Do not move vehicle until mast has been securely stowed.

⚠ WARNING

Using the emergency stow button causes the actuator to lower the mast without regard to any faults, switches, or system interlocks. It is totally up to the operator to ensure safe operation during an emergency stow attempt.

⚠ WARNING

When using the emergency stow button, normal operation switches are disabled. The mast can be overdriven into saddle and cause damage to the unit.

⚠ WARNING

If manually lowering the mast, make sure all power has been disconnected from the system prior to manually lowering the mast.

⚠ WARNING

Keep hands clear of the descending collars while the mast is being lowered to avoid pinching.

⚠ WARNING

A pneumatic telescoping mast is a pressurized vessel. Caution must be exercised to stay clear when the mast is being extended. Do not lean directly over the mast. Proper eye protection should be worn when working on the mast.

⚠ WARNING

Do not lubricate the exterior of the mast. This will cause the lubricant to attract dust and contaminants from the air.

⚠ WARNING

Make sure the lights are completely cool before attempting to clean the light lenses.

⚠ WARNING

Make sure all power has been disconnected from the system prior to manually lowering mast. This can be accomplished by turning all breakers to the OFF position.

⚠ WARNING

Safety Instruction – Hard Hat! Due to the risk of head injuries from falling objects, operators should wear a properly secured hard hat while the mast is in the process of being deployed, deployed, or in the processes of being stowed.

⚠ CAUTION

Safety Instruction – Operation! Lamps are extremely hot and should not come into contact with people or combustible and/or explosive materials. Do not operate if breakage occurs or unit is knocked over.

⚠ CAUTION

Entanglement Hazard! Tangled cables can cause equipment damage. Ensure control cables are not tangled and are free to pay out as mast is raised.

⚠ CAUTION

Safety Instruction – Operation! Do not operate the mast during an electrical storm.

⚠ CAUTION

Lifting Hazard! Manually lifting over 55 lb. (25kg) is prohibited. In the UK, all lifting equipment must be thoroughly examined annually by a competent person according to the Lifting Operations and Lift Equipment Regulations 1998. Equivalent regulations exist in other EU states.

⚠ CAUTION

Safety Instruction – Operation! All operators must read the Operation section of this manual and be properly trained.

Section 1 Introduction

Review this manual in its entirety. Contact the Will-Burt Company with any questions before performing any procedure outlined in this manual.

The Night Scan Powerlite® 2.3 and 1.8 are a 12 VDC powered transportable lighting systems consisting of directionally adjustable LED lights attached to a self-erecting extendable mast. The Powerlite 2.3 and 1.8 come standard with four Night Scan XL 160 lamps (P/N: 5048201) which produce a total of up to 60,000 lumens. For other lighting options, contact Will-Burt. The lights are split into two sets, one set found on either side of the dual-tilt remote controlled positioner (RCP) (P/N: 4742501). The RCP allows each group to tilt independently. The fold-down mast and base (P/N: 5052901) is roof-mounted and typically does not require any interior vehicle space.

1.1 Safety Precautions

Refer to the Safety Summary for precautions to be observed while operating or servicing this equipment.

1.2 How this Manual is Organized

This manual describes the installation, operation, and maintenance of the Night Scan Powerlite 2.3 and 1.8 fold-down masts. Typical hardware includes the base, mast, lights, remote controlled positioner, and a controller to operate the system.

This manual is organized into the following sections:

Section 1 Introduction

Section 2 Installation

Section 3 Operation

Section 4 Maintenance and Adjustments

Section 5 Reference Information

Section 6 Troubleshooting

Section 7 Appendix

Section 8 Drawings

1.3 Additional Documentation

In addition to this manual, your system ships with top-level drawings. These drawings can be referenced during the installation process.

1.4 The Definition of the Mast Position

An actuator electrically raises the mast from the stowed position to the 90° position. The mast is then pneumatically moved by air pressure to the extended position. The following positions (Figure 1-1) are used throughout this manual:

- “Stowed” is the horizontal position in which the mast is firmly seated in the saddle. This position is sometimes referred to as the “nested” position.
- “90°” is the position that the mast electrically goes to from the stowed position. At 90°, the mast has angled up, but no mast sections have risen. The mast remains retracted.
- “Extended” is the partial or full raised position that the mast pneumatically goes after the 90° position. In the extended position, some or all of the mast sections have risen.

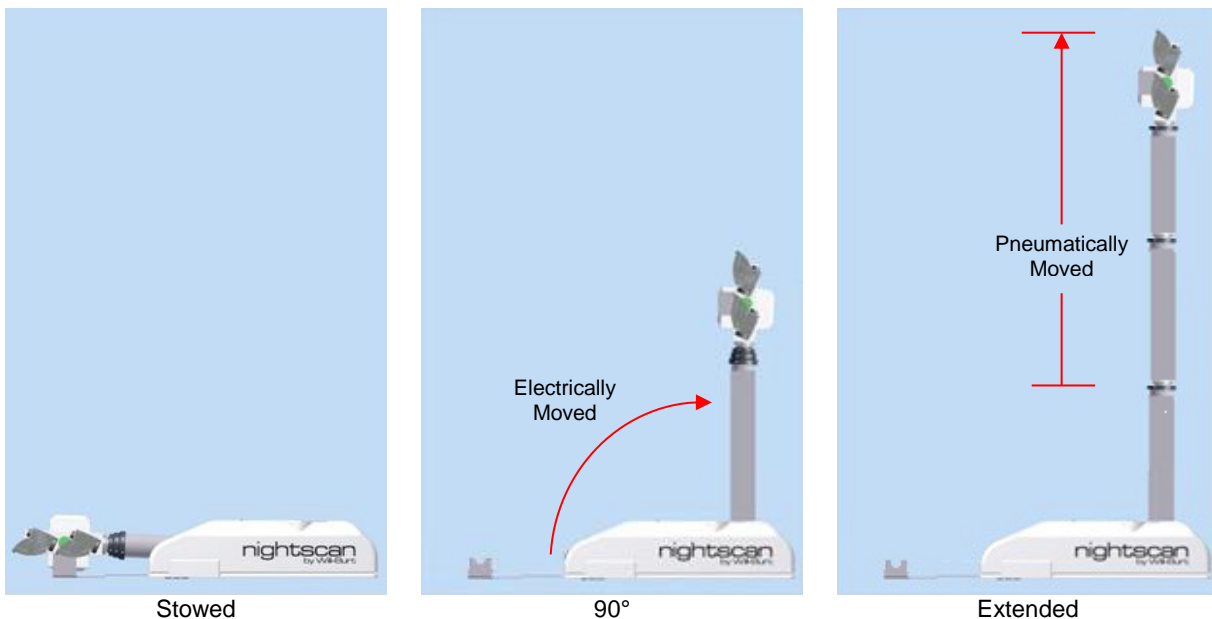

Figure 1-1 Mast Positions (Night Scan Chief shown)

1.5 Major Components

The major components of the Night Scan Powerlite 2.3 and 1.8 system are:

- Base
- Remote Controlled Positioner (RCP)
- Lights
- Controller

Refer to Figure 1-2 for identification of major components of the Powerlite 2.3 and 1.8.

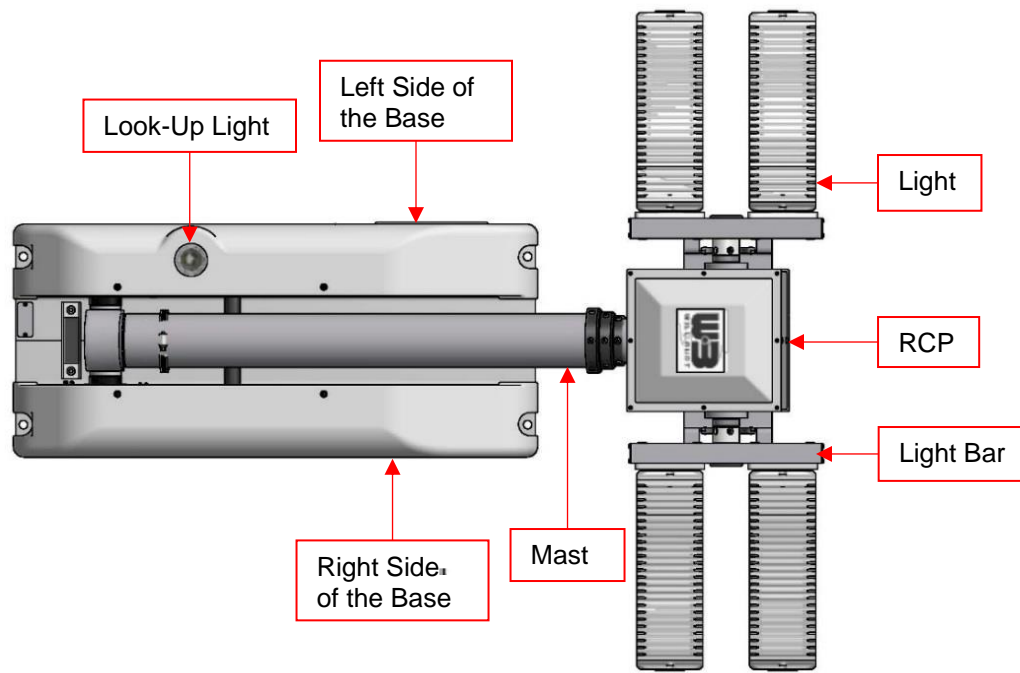

Figure 1-2 Night Scan Powerlite 2.3 and 1.8 Parts

1.5.1 Base

The base normally mounts to a vehicle roof and consists of:

- Mast
- Base
- Saddle

The following information lays out the general pattern of the base. The exact configuration of the base in your system may vary. For detailed information on the base in your system, see the drawings that shipped with your system.

1.5.1.1 Mast

The bottom of the mast connects to the actuator. The bottom of the mast also connects to the air compressor which extends the mast. When at 90°, the mast bottom rests on a firm rubber padding on the base. The top of the mast connects to the RCP.

The mast contains (Figure 1-3):

- Tube Sections
- Magnetic Down Switch
- Internal Coil Cord (Figure 1-4)

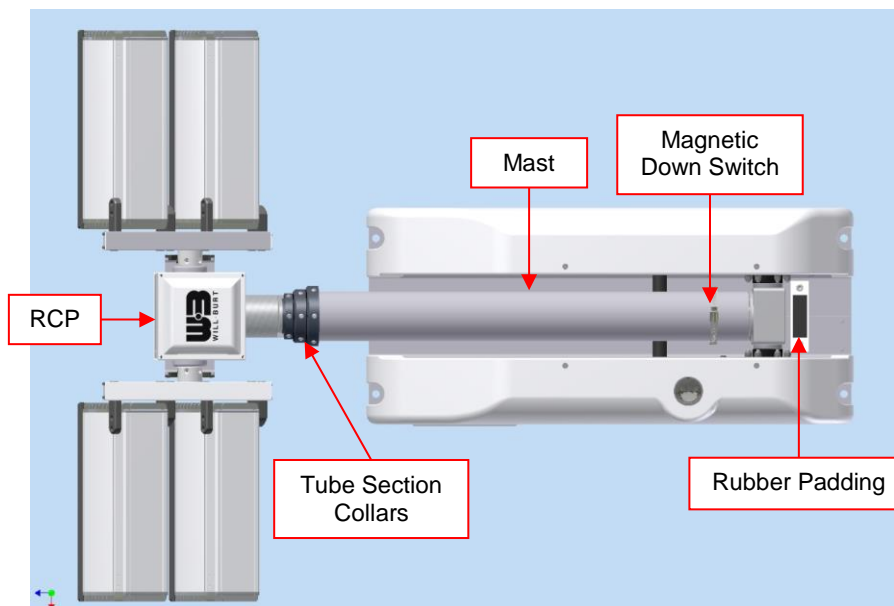

Figure 1-3 Mast Components (Night Scan Chief shown)

Tube Sections

The mast consists of concentric sections that extend as air is applied. Each tube and collar is protected by low friction synthetic bearings for smooth operation and long life. Bumpers reduce shock on extension and retraction. The exterior surfaces of the tubes are anodized and sealed for long life. The fasteners are corrosion-resistant stainless steel.

Magnetic Down Switch

The mast contains a Magnetic Down Switch fastened to the outside of the bottom tube section with a clamp. This switch senses a magnet in the top tube which indicates the mast is fully retracted (all air exhausted) and ready to be stowed. This switch is adjusted at the factory.

Internal Coil Cord

The center of the tubes route an internal coil cord from the bottom of the mast to the RCP (Figure 1-4). The highly flexible internal coil cord contains communications and light power to the RCP.

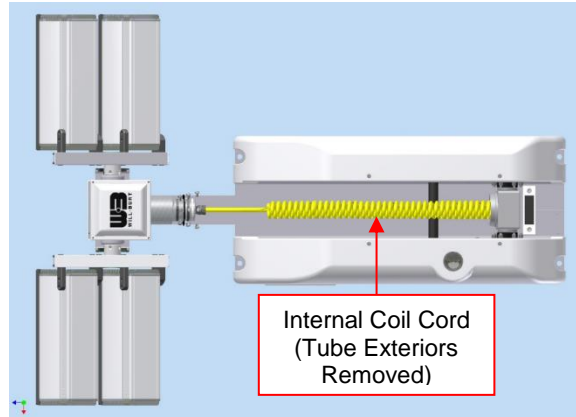

Figure 1-4 Internal Coil Cord (Night Scan Chief shown)

1.5.1.2 Left Side of the Base

The left side of the base (viewed from rear of the mast) is covered with a plastic housing (Figure 1-5). The left side of the base contains:

- Look-Up Light
- Base Board
- Access Holes

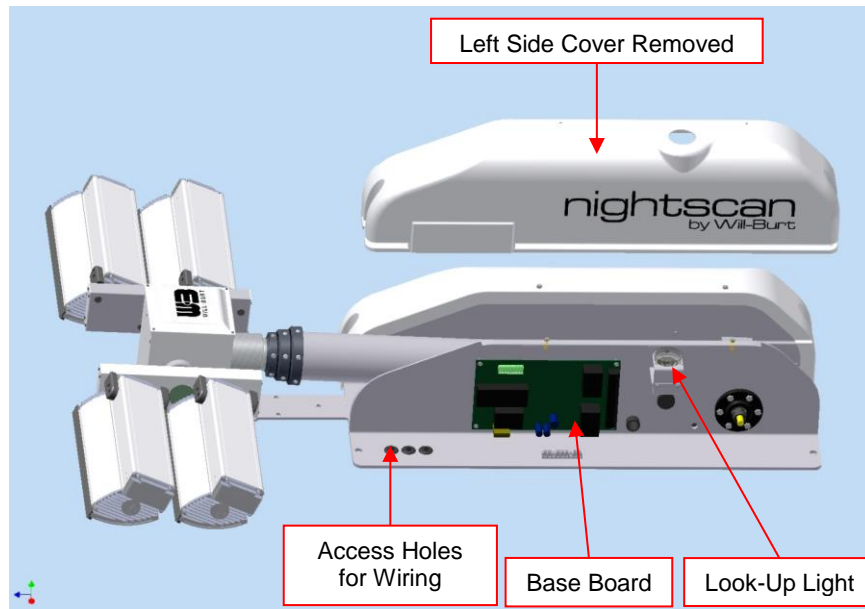

Figure 1-5 Left Side of the Base

Look-Up Light

The look-up light allows the operator to see obstructions and power lines, and helps keep the operator and equipment safe. Whenever an operator at the controller moves the mast or RCP, the look-up light automatically turns on. The look-up light automatically turns off when the mast and RCP motion stops. For example, the look-up light turns on when the mast moves to leave the stowed position, when the mast is raised or lowered, and when the RCP is rotated.

Base Board

Night Scan Universal (NSU) Systems use a Base Board (P/N: 4311701) with v7.3 or higher software. The Base Board is the main board in the system. It handles communication between the controller and RCP. The Base Board contains diagnostic LEDs that show sensor positions, a status light which shows errors, and terminal strips for wire connections (Figure 1-6). Communications and light power to the mast are controlled at the Base Board.

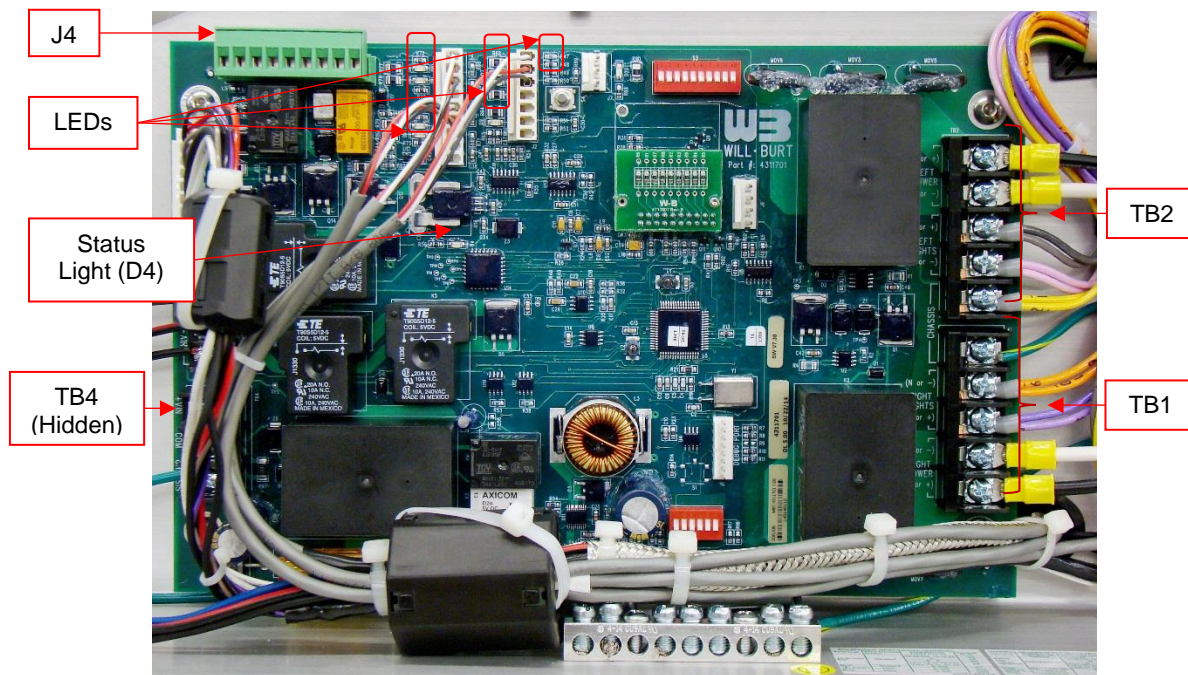

Figure 1-6 Base Board (P/N: 4311701)

Access Holes

The access holes on the left side of the base provide holes for the required cables. These cables are for light power, base power, and control lines for the system.

1.5.1.3 Right Side of the Base

The right side of the base (viewed from rear of the mast) is covered with a plastic housing (Figure 1-7). The right side of the base contains the following:

- 90° Switch
- Mast Stowed Switch (Near 0° Switch)
- Actuator
- Air Compressor

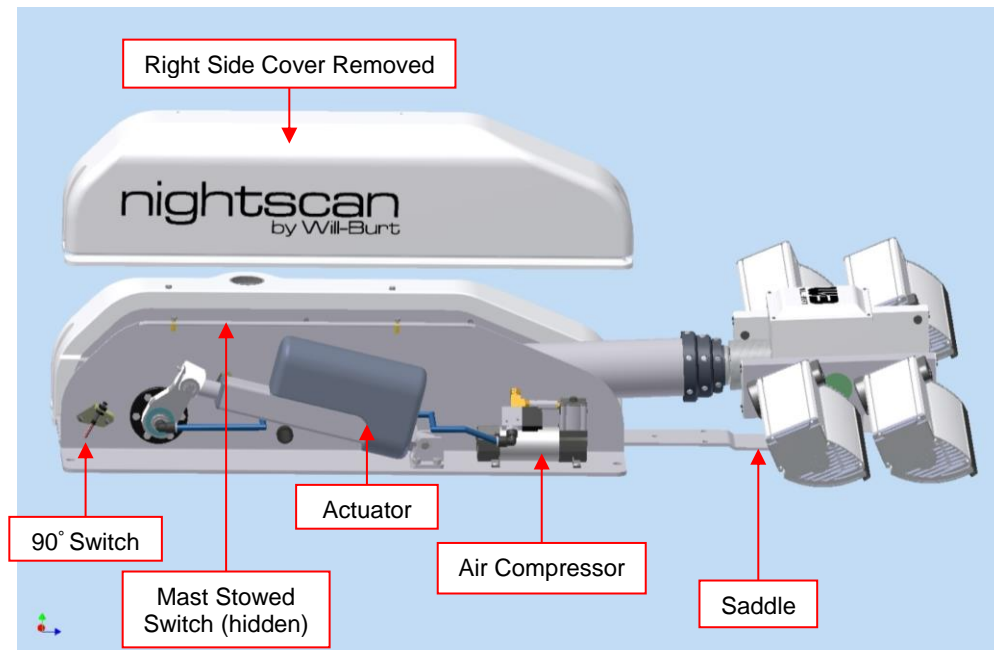

Figure 1-7 Right Side of the Base

90° Switch

The 90° Switch senses the actuator position to determine when the mast is at 90°. Once at 90°, the lights and RCP are enabled. The operator can then use the controller to move the lights, and turn them on and off.



Mast Stowed Switch (Near 0° Switch)

The Mast Stowed Switch senses the actuator position to determine when the mast is stowed and firmly seated in the saddle. The circuit looks for a pre-determined current rise (for a maximum of 0.5 seconds) to indicate a solid nesting before shutting off.

Actuator

The actuator moves when it receives a command from the operator at the controller. Electrically DC driven, it moves the mast upward from the stowed position to the 90° position and downward from the 90° position to the stowed position.

Air Compressor

The DC air compressor supplies air to raise the mast when the operator presses the “Mast Up”  button on the controller after the mast electrically reaches the 90° position. There is no mast fully extended switch. Once full extension is reached, if the “Mast Up”  button is not released, the maximum air pressure is reached and the blow-off valve opens. At this point, excess air is vented and the mast remains at the fully extended height.

1.5.1.4 Saddle

The saddle (Figure 1-7) is connected to the bottom of the base and extends outward to provide a curved surface for the RCP shaft to rest on when the mast is stowed. The saddle, along with the base plate, has holes that are used to secure the base to the vehicle roof. The distance the saddle extends out from the base will vary based on your system.

1.5.2 Remote Controlled Positioner (RCP)

The dual-tilt RCP (Figure 1-8) mounts on top of the mast and between the lights. The RCP contains gears and gear motors to position the lights. The RCP also contains the RCP Board which receives data through the Base Board from the controllers. This allows the RCP to control the lights to pan and tilt. The dual-tilt RCP allows for individual tilt control of each side of lights. For example, one side of the lights could be directed forward, while the other side of the lights could be directed backward.

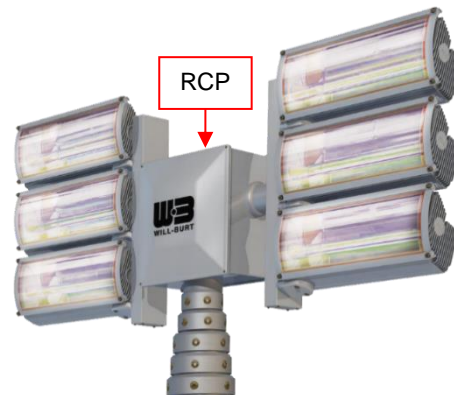

Figure 1-8 Dual-Tilt Remote Controlled Positioner (RCP) (Shown with lights attached)

1.5.3 Lights

The Night Scan Powerlite 2.3 and 1.8 comes standard with four Will-Burt XL-160 LED lights (Figure 1-9). For additional information on the lights, see www.willburt.com. For information on other lighting options, contact Will-Burt.



Figure 1-9 Night Scan Powerlite 2.3 and 1.8 Lights

1.5.4 Controllers

Several controllers are available for your system. These controllers all have two-way communication with the system and LED display that include alphanumeric feedback. The controllers can be used to operate all functions of the system and are as follows:

Wired Hand-Held Remote Controller (HHRC)

The wired HHRC (Figure 1-10) has the following features:

- Connects with a 25 foot (7.62 meter) bayonet-disconnect coiled cord
- Integrated emergency stop button

Panel Mount Remote Controller (PMRC)

The PMRC (Figure 1-10) has the following features:

- Integrated emergency stop button

Wireless Hand-Held Remote Controller (HHRC)

The wireless HHRC (Figure 1-10) has the following features:

- Operates as a wireless unit using a rechargeable internal power source, or as a wired unit when connected directly with a cable
- Assigns a unique communication channel with the J-Box when a direct connection is made during system initialization
- Emergency stop button on separate J-Box
- Connects with a 25 foot (7.62 meter) bayonet-disconnect coiled cord



Figure 1-10 Dual-tilt controller options. Standard (non-NFPA) models appear the same, except that they do not have the green NFPA Start button.

1.5.4.1 Controller Interface

The wired HHRC connects through a bulkhead (Figure 1-11). The PMRC connects directly to the system. The wireless HHRC connects through a J-Box with a “Start/Stop” button (Figure 1-12). The “Start/Stop” button on the J-Box serves as an emergency stop. The wireless HHRC plugs into the J-Box to recharge, and during the initialization process to establish wireless communication.

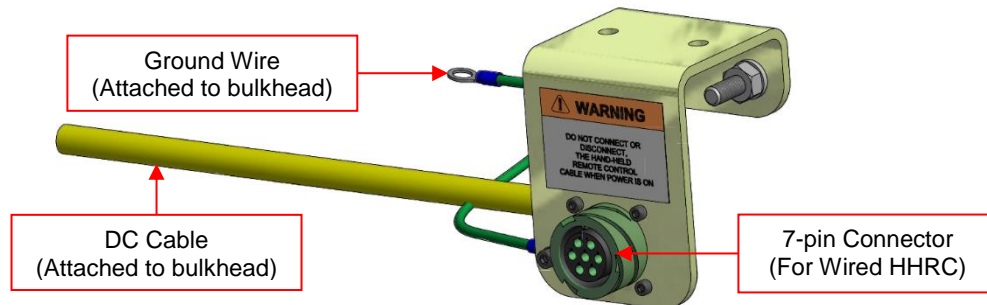

Figure 1-11 Bulkhead

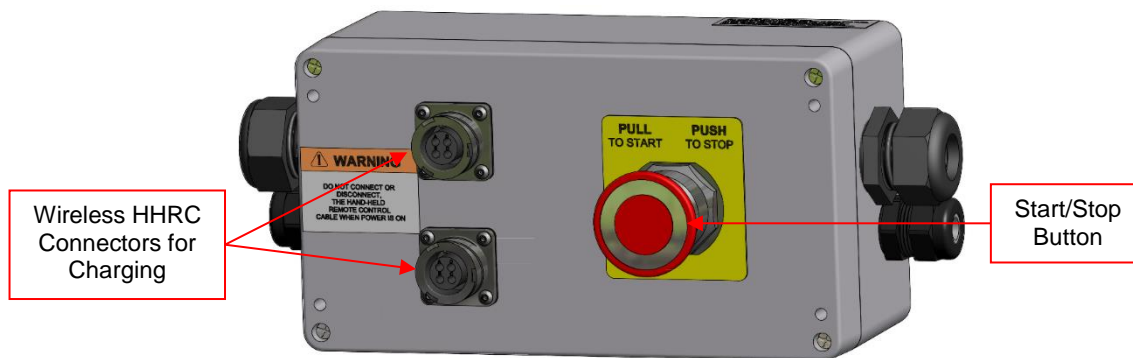

Figure 1-12 J-Box

1.6 Unit Specifications

Table 1-1 lists the specifications for your system.

Table 1-1 Night Scan Powerlite 2.3 and 1.8 Specifications

Functional Characteristic	NS Powerlite 2.3	NS Powerlite 1.8
Extended Height	7.5 ft. (2.3 m)	6 ft. (1.8 m)
System Weight Range	125 – 179 lb. (57 – 81 kg)	97 – 135 lb. (44 – 61 kg)
Automatic Deploy and Stow	Yes	Yes
Strobe Light Option	Yes	Yes
Camera Option	Yes	Yes
*Wind Speed Survival	114 – 140 mph (184 – 225 km/h)	140+ mph (225+ km/h)
*Varies depending on light package – 125% NFPA Safety Factor		

Section 2 Installation

This section describes the installation of your system and provides the general procedures that must be followed to ensure a successful installation. Be sure to read and understand the entire installation procedure before beginning installation.

2.1 Ensuring That it Fits

Roof-mounted systems are often stowed in a compartment on the vehicle roof. Ensure that the mounting surface is flat, and that the base and saddle are in the same plane. Be sure to mount the system out of reach of anyone who may be near the vehicle to allow the mast to be safely raised and lowered. Ensure that there is sufficient room and roof strength to mount the system.

2.1.1 Dimensions

The exact dimensions of your system will vary based on the components included. Refer to the drawings which ship with the mast for detailed information on the size of the base. Additional room may be required for additional components such as optional cameras or strobe lights.

2.1.2 Mast Loads

It is important that both the base and the saddle be securely mounted to a sturdy roof or platform which will not overturn during operational loading of the mast. The surface must be reinforced to withstand the load at the different points on the mast that can be expected during operation as shown in Figure 2-1. All values are given in lb. These are maximum load estimates placed downward and sometimes upward on the vehicle top by the mast.

2.1.1 Mast Loads

It is important that both the base and the saddle be securely mounted to a sturdy roof or platform which will not overturn during operational loading of the mast. The surface must be reinforced to withstand the load at the different points on the mast that can be expected during operation as shown in Figure 2-1. All values are given in lb. These are maximum load estimates placed downward and sometimes upward on the vehicle top by the mast.

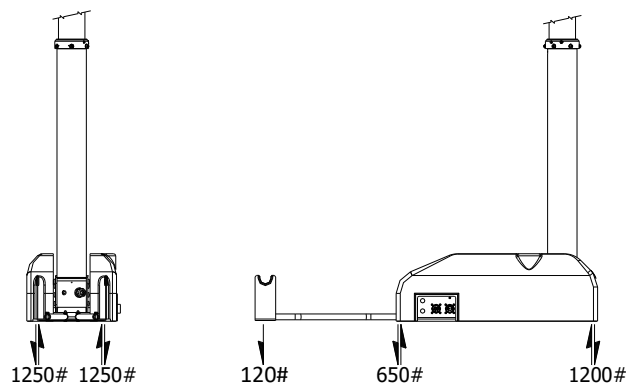

Figure 2-1 Load Distribution

2.2 Get Your Tools

Table 2-1 lists recommended tools and materials for installation.

Table 2-1 Tools and Materials Recommended for Installation

Tools and Materials		
Safety Glasses	Safety Gloves	Safety Shoes
Hard Hat or Helmet	Hearing Protection	Crimping Tool or Solder Set
Wrenches	Screwdrivers	Multimeter (To verify power is turned off)
Torque Wrench	Drill	Knife or scissors to cut plastic band
Wire cutter/stripper	RTV Silicone	½ inch or M12 Mounting hardware (6 each)
Clean shop rags	Hoist (minimum 500 lb. capacity)	
Note: Depending on the national and local standards and codes of practice, and the environment, additional personal protective equipment may be necessary.		

2.3 Components

When unpacking, check to ensure all ordered components have arrived. Your system should ship with the following components:

- Base Assembly
- RCP Assembly
- Lights
- Controller (Selected from the following)
 - Wired HHRC with Bulkhead
 - Wireless HHRC with J-Box
 - PMRC
- Bulkhead Control Cable
- DC Light Cable
- Ferrite
- Label Kit
- Operator's Manual (this manual) on CD
- Drawings of your system to assist in the installation process

The labels from the label kit can be applied where the operator deems appropriate.

2.4 Unpacking

Unpack the items as follows:

1. Carefully remove all the cartons.
2. Remove all the items from the cartons.
3. Ensure that all components are included and that the required tools are readily available.
4. Inspect for any shipping damage. If damage has occurred, notify your carrier.
5. Lift the base out with a hoist. Lift the Powerlite 2.3 and 1.8 from the shipping container by the mast tube at the labeled point (Figure 2-2). Do not lift the Powerlite 2.3 and 1.8 by the RCP. Lifting from locations other than those indicated could result in equipment damage.

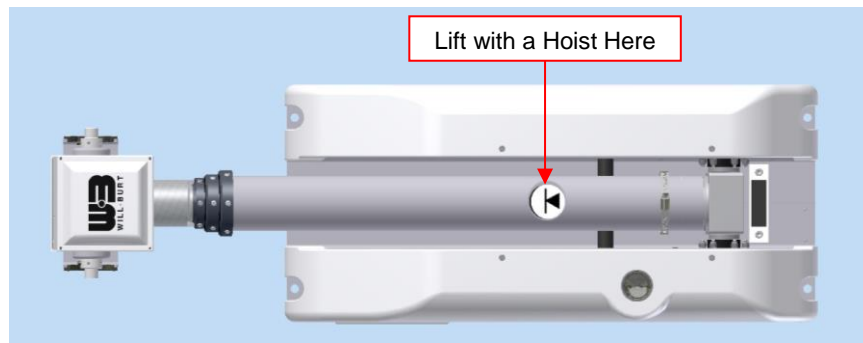

Figure 2-2 Lifting Point on the Powerlite 2.3 and 1.8

2.5 Attaching to the Vehicle

Your system is designed to withstand adverse weather conditions; however, it cannot be submerged in water. Hardware for attaching the base to a roof is not included with the shipped items.

Physically attach the system as follows:

1. If the system is mounted in a well, provide adequate drainage. A minimum of four 1" diameter drain holes (one per corner) are recommended.
2. Ensure that the mast base and saddle are on a flat surface and in the same plane. Switches set at the factory are based on a level surface. If the system is not level, these switches may need adjusted as described in Section 4 of this manual.
3. The areas to which the unit is mounted must be reinforced to withstand mast loads. Be sure to mount the unit out of reach in order to ensure safety distances and prevent hazardous zones being reached by upper extremities of operator or bystanders.
4. See Figure 2-3 for mounting hole locations for your system. These locations will vary based on which system you are using. Drill six 9/16" mounting holes into the vehicle mounting structure in the mounting locations. There are four holes for the base, and two holes for the saddle.

- Attach the base to the roof using 9/16" bolts. Torque all hardware as appropriate for its material and size. The two saddle bolts can be attached later when power is available since the mast has to be partially raised to insert the bolts. Adjust the location of the saddle if necessary so that the saddle flanges do not hang up on the lights when the unit is raised.

It is the responsibility of the customer to properly secure the payload for vehicle travel.

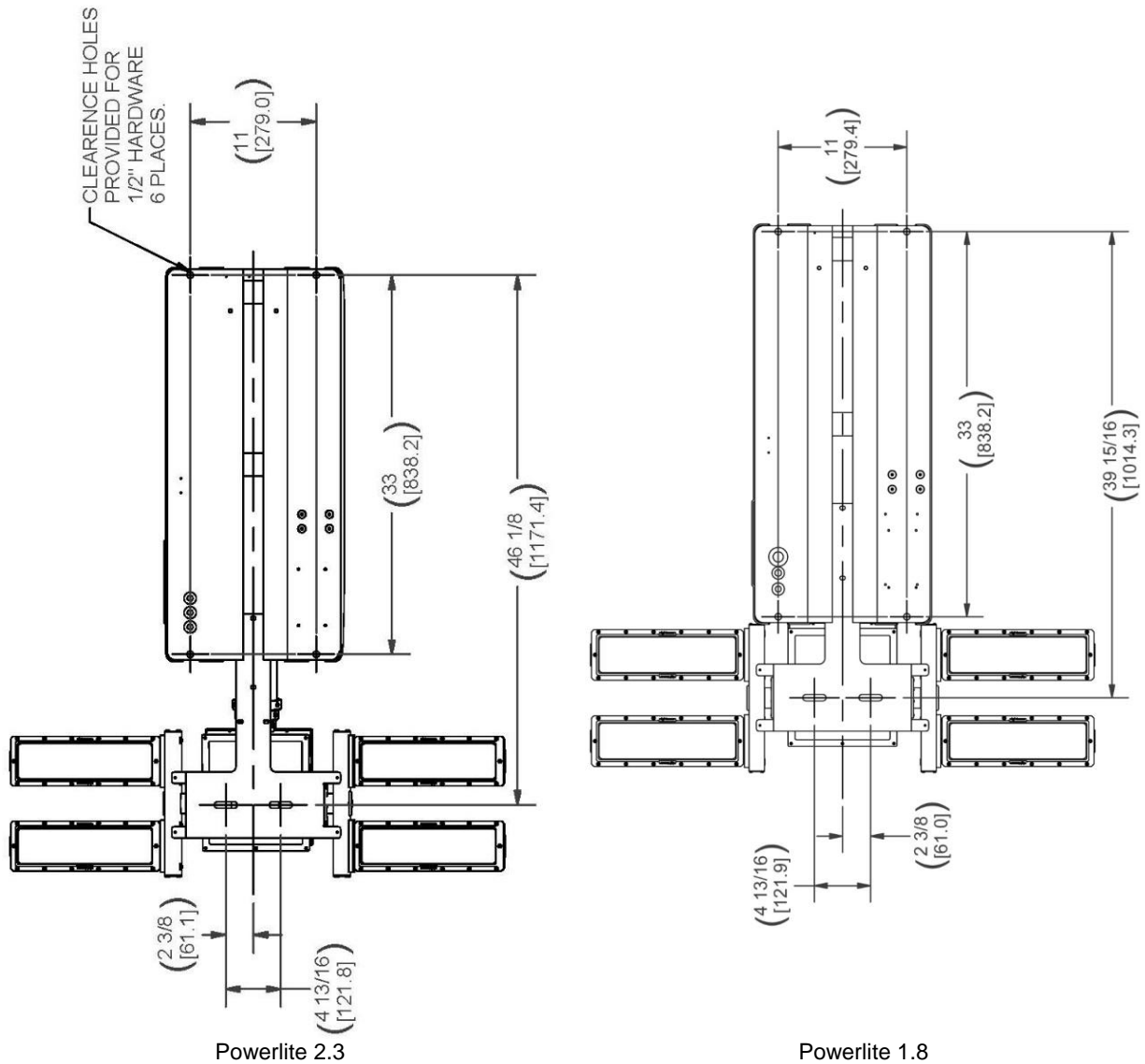

Figure 2-3 Mounting Hole Locations (Bottom View)

2.6 Attaching the Controller

There are several types of controllers available for your system. This section will describe how to install the Wired HHRC with a bulkhead. The installation process for other controllers will be described in the Appendix.

To attach the bulkhead:

1. Find a convenient, dry location to mount the bulkhead.
2. Drill the mounting holes as indicated (Figure 2-4).

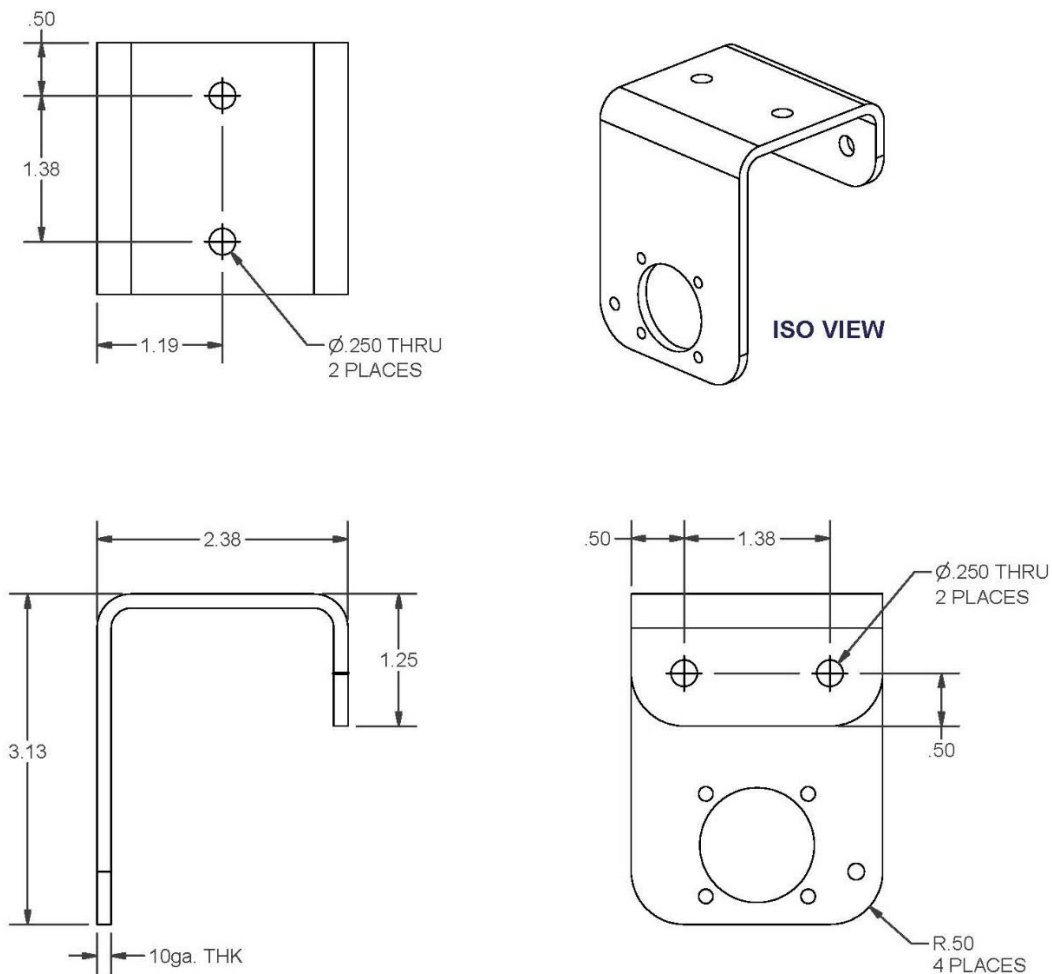

Figure 2-4 Bulkhead Dimensions

3. Using the screws, washers, and nuts provided, attach the bulkhead to the vehicle.
4. Attach the ground wire to the vehicle.

2.7 Attaching the Holder

The HHRC has a holder to hang the controller on. To install the holder:

- Using the (2) screws and the holder provided, attach the holder where the HHRC will hang. The inside of the holder is angled to better hold the HHRC (Figure 2-5). Ensure that the wider end of the bevel is up.

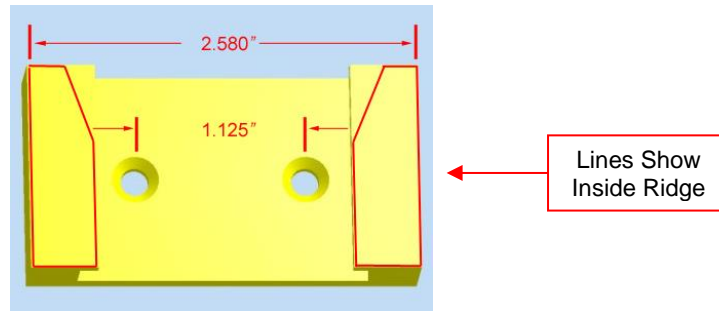

Figure 2-5 Holder for the Controller

- Place the HHRC onto the holder.

2.8 Wiring the Base Board

To electrically connect the base, proceed as follows:

- Loosen the three screws from the cover of the base, remove the cover, and run the Bulkhead Control Cable connected to the bulkhead into the bottom of the base.

2.8.1 Wiring the Bulkhead Control Cable to the Base Board

The Bulkhead Control Cable connects the bulkhead, controller, and Base Board.

- Connect the wires from the Bulkhead Control Cable to the green J4 connector ensuring the wires match the color strip on the J4 connector (Figure 2-6).

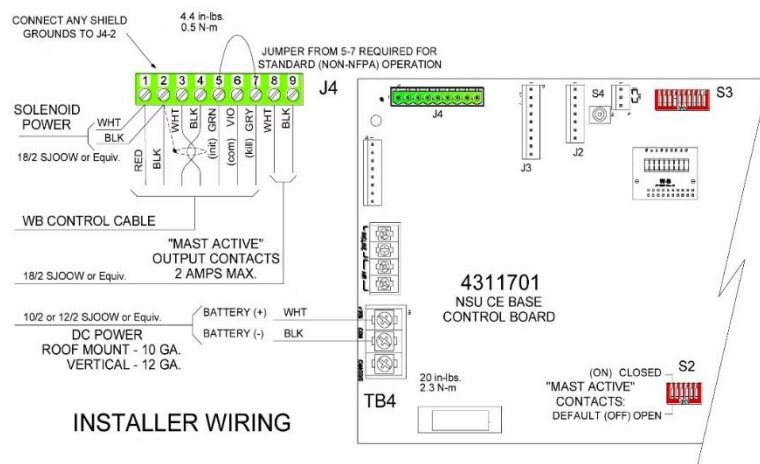

Figure 2-6 Wiring J4

If using the “Mast Active” contacts, note that they are factory set to be OPEN when the mast is active; S2-1 is OFF (open). To set them to be CLOSED when the mast is active, set S2-1 ON (closed).

Important! Be aware of the different "look" of the ON position of rocker and slide switches. Both are shown (Figure 2-7) with position 1 ON (closed).

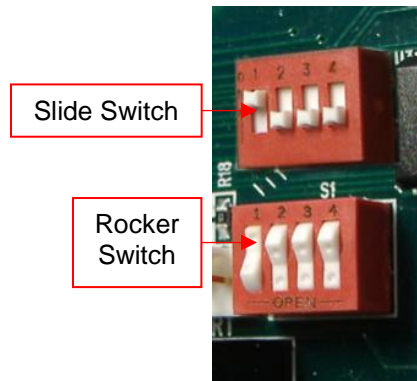

Figure 2-7 Switches

2.8.2 Wiring the DC Power to the Base Board

Incoming DC power is provided by the customer from the vehicle battery.

2. Connect the DC battery power to the +VIN (red or white) and COM (black) connections on terminal block TB4 on the Base Board (Figure 2-6). The source must be capable of delivering 15 amps minimum.

2.8.3 Wiring the Lights to the Base Board

Light power is provided with four lines; two for the left light power and two for the right light power. To calculate the current draw for the wires:

- a. Divide the total watts by two.
- b. Divide the result by the voltage.
- c. This final result is the amperage required for each side.

In the example (Table 2-2), the lights in the system are a total of 500 watts. This is divided by two to get the watts per side. The result is then divided by the voltage (12) to get the amps. The wires in this example should be able to carry at least 21 amps with minimal voltage drop. The system can accept up to 8-gauge wire (recommended). **IMPORTANT! The use of 8 gauge wires provide minimal voltage drop, especially for 12 VDC lights. The circuit protection should be sized for the required amperage of the lights, not two 8-gauge wires!**

Table 2-2 Sample Amp Calculation

	Total Watts	Voltage	Current Draw Per Side (Amps)
Example	500	12	21

There are two inputs on the base Board: LEFT POWER and RIGHT POWER. To wire the Light Power to the Base Board:

- If 12 VDC lights, because of the higher current draw, line drop from the source to the unit may be a problem. The user should calculate the line drop for the lights used based on the cable size/length of run. The lights need 12 VDC minimum at the board under all expected operating conditions. It is recommended that two separate 12 VDC power feeds be run to the base board (four wires total). For lower total wattage lights kits (under 20 amps), one \pm pair of 12 VDC lines connect to the bottom (RIGHT POWER) on TB1 terminal block. The other \pm pair of 12 VDC lines connect to the top (LEFT POWER) of TB2 terminal block. Note: 10-gauge max.

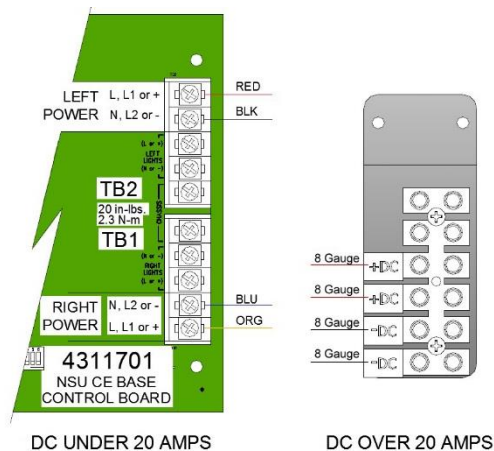

Figure 2-8 Light Power Inputs

- For higher total wattage light packages (over 20 amps), connect four 8-gauge DC cables to the terminal block mounted to the Look-Up light. The connection to the system is pre-wired at the factory.
- Secure all loose wires with wire ties.
- Attach the 0.709" inside diameter ferrite (shipped with the mast) around the Bulkhead Control Cable as it enters the base. This ferrite provides EMI (electromagnetic interference) filtering.
- Replace the base cover.

2.9 Connecting the Warning Light/ Interlock Output Contact

The mast provides an isolated relay contact output to enhance integration into vehicle safety circuitry (Figure 2-9). This relay output is from a bi-stable (latching) relay whose contacts either open or close (switch selectable) when the mast is active (not stowed). Its state is not affected by whether or not there is power to the mast. This contact is capable of carrying up to two amperes and is available on pins J4-8 and 9. Its usage is highly recommended by Will-Burt and should be used to comply with various safety standards. It can be used in conjunction with a customer-supplied relay to drive a flashing warning light.

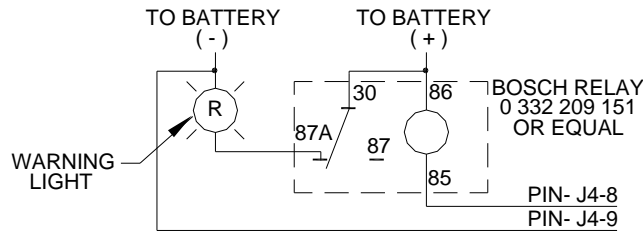

Figure 2-9 Relay

2.10 Connecting the Interlock Input Contact

Some safety standards requires preventing operation of the mast unless other conditions are first met. An example might be having the parking brake set. This can be accomplished by inserting an isolated contact in series with the stop circuit of the “Start/Stop” button. Inserting these contacts in line with the wire connected to pin J4-7 on the base circuit board breaks continuity and will inhibit operation of the mast and prevent operation until the parking brake is set. After use, and properly stowing the mast, when the parking brake is released, the mast is again prohibited from energizing until the parking brake is set.













Note: Using this parking brake feature is the same as pushing the E-stop button—power to the control is opened, the mast immediately exhausts air, and the mast comes down without regard to the proper RCP alignment (stowing to the home position). The parking brake should not be released until the mast is safely (and automatically) stowed by the controls.

For Standard (non-NFPA) mode, to force the mast to Auto Stow® if the vehicle emergency brake is off, replace the jumper on connector J4, wires 5 and 7, with the contacts from the parking brake. The contacts should close when the brake is on.

2.11 Testing the Installation

Review the operation section of this manual and observe all safety dangers, warnings, and cautions in this manual before proceeding to test the installation. If any part of the testing fails, check the LEDs on the controller and Base Board.

To test the installation, proceed as follows:

1. Reconnect power.
2. Turn the red “Start/Stop”  button to enable the system, then push the green “Start”  button.
3. Check for proper clearance above the mast.
4. Press the “Mast Up”  button twice rapidly. This invokes the Auto-up feature.
5. Press each “Light”  button several times to turn the lights on and off.
6. Tilt ( and ) and pan ( and ) both sets of lights. Check the lights on each side again.
7. Press and hold the “Mast Up”  button. When the mast is fully extended and the blow-off valve opens, release the “Mast Up”  button.
8. Press each “Light”  button several times to turn the lights on and off.
9. Tilt and pan both sets of lights. Check the lights on each side again.
10. If the strobe/beacon light is installed, press the “Auxiliary Light”  button several times to turn the light on and off.
11. To ensure that the mast is properly sealed, while the mast is fully extended, watch for any type of mast settling.
12. Press the “Mast Down”  button twice rapidly. This invokes the Auto Stow[®] feature that places the mast into the saddle and turns power off.

Note: Before delivery of a new system, the 90° and Mast Stowed (Near 0°) switches are set and tested for a flat surface. If the mounting surface is not flat, the 90° and Mast Stowed switches may need adjusted to function properly. If necessary, see Section 4 for details on adjusting the 90° and Mast Stowed (Near 0°) switches.

Section 3 Operation

This section describes the operation of the system. Be sure to read and understand the entire operation procedure before beginning operation.

3.1 Pre-Operation Check

Before operating the system:

1. Ensure that there are no overhead obstructions, and that there are no power lines within 20 feet of the mast.
2. Visually inspect the system for damage. If damage is apparent, do not use the mast and have it serviced prior to use.
3. Check for and remove any objects which might obstruct motion of the mast; cause binding; or hinder mast function.
4. Ensure that the following warnings are understood and followed:

⚠ WARNING

Make certain that the area is free of overhead power lines and other unwanted sources of electricity. Follow OSHA safety regulations when working near energized power lines. Be sure to allow sufficient clearance on all sides of mast to allow for side-sway.

⚠ WARNING

Safety Instruction – Operation! For outdoor use only. Do not use in areas that have been classified as hazardous as defined in Article 500 of the National Electric Code.

⚠ WARNING

Do not use in the presence of flammable gases or liquids such as paint, gasoline or solvents. Do not use in areas of limited ventilation or where high ambient temperatures are present. Contact with combustible materials can cause ignition resulting in fire or explosion.

⚠ WARNING

Keep personnel clear of mast while during operation.

⚠ WARNING

Do not move vehicle until mast has been securely stowed.

⚠ CAUTION

Safety Instruction – Operation! All operators must read the Operation section of this manual and be properly trained.

3.2 Controllers

The following controllers are available on your system:

- Dual-Tilt Wired Hand-Held Remote Controller (HHRC)
- Dual-Tilt Panel Mount Remote Controller (PMRC)
- Dual-Tilt Wireless Hand-Held Remote Controller (HHRC)



Using the controller, the operator can move the mast up and down, tilt the lights up and down, pan the lights right and left, turn the lights on and off, and turn the optional strobe light on and off. The following are the controller buttons:



The “NFPA Start” button is only found on NFPA controllers.

There are three duplicate buttons on the controllers:



- Tilt Down 
- Tilt Up 
- Lights 













These buttons operate the separate sides of the RCP. For example, if you Press the “Tilt Down”  button on the right side of the controller, the lights on the right side will go down. If you press the “Tilt Down”  button on the left side of the PMRC, the lights on the left side will go down.

3.3 Quick Summary



Following is a quick summary of the operation of the system. Detailed steps follow the quick summary.

If an emergency stop is required at any time, press the “Start/Stop”  button. This will disconnect the unit from power and cause all air to be exhausted from the mast.



1. Ensure that the vehicle parking brake is engaged.
2. Ensure that there are no obstructions overhead.
3. Turn the red “Start/Stop”  button. For NFPA systems, then press the green “NFPA Start”  button.





4. Raise the mast to 90° and turn on the lights by performing one of the following steps:
 - Quickly press the “Mast Up”  button twice (Auto-up feature) to move mast to 90° and turn both banks of lights on. To abort the Auto-up feature, press any controller button.
 - Press and hold the “Mast Up”  button to raise the mast. Then press the “Lights”  to turn the lights on. The RCP will become active when the mast is at 90°. Only the controller buttons that have a lit LED are active.
5. If desired, raise the mast further by pressing “Mast Up” .
6. Position the lights vertically by pressing “Tilt Down”  and “Tilt Up” .
7. Position the lights horizontally by pressing “Pan Right”  and “Pan Left” .
8. Use the “Lights”  button to turn on the strobe/beacon light (if equipped).
9. If desired, lower the mast by pressing “Mast Down” .
10. Stow the mast by performing one of the following steps:
 - Quickly press the “Mast Down”  button twice (Auto Stow[®] feature). It is recommended to use the Auto Stow[®] feature to stow the mast. To abort Auto Stow[®], press the any controller button.
 - Press and hold “Mast Down”  until all LEDs on the controller turn off. Ensure that “Mast Down”  is released only after the controller LEDs turn off which means the mast is stowed.

3.4 Initiating

Before operating a stowed mast, the “Start/Stop”  button must be turned. This will enable the system to power up and initiate. NFPA systems must also then press the green “NFPA Start”  button. On initiation, the Base Board establishes communication with the other boards in the system. If communication cannot be established, an error code is shown on the display and the communication system is shut down.

To initiate the system:

1. If using a wired HHRC, ensure it is plugged in before initiation. This allows the board to establish communication between all boards. If the wired HHRC is connected after the unit is powered up, then an error will occur.
2. Turn the “Start/Stop”  button while viewing the display.
3. For NFPA operation, wait until the system initializes before releasing the “Start/Stop”  button. When the first letter “N” of NightScan is shown on the controller display, release the “Start/Stop”  button.

4. The letter “N” of NightScan is normally displayed a couple of seconds after turning the “Start/Stop”  button. You may also be able to hear the initiate relay click into place. Do not release the “Start/Stop”  button before seeing the first letter on the display. Releasing too early may cause a communication error between the Base Board and the controller. After the letter “N” of NightScan is displayed, the “Mast Up” LED is lit showing that the “Mast Up”  button is enabled.
5. For NFPA controllers, press the green “NFPA Start”  button.



3.5 Raising the Mast to 90°

The mast uses a DC powered actuator to drive the mast from stow to 90°. When at 90°, a proximity sensor detects the actuator then drives the actuator a bit further. Driving the actuator a bit further causes the mast to seat firmly into the foam mast pad. Do not overdrive the actuator or damage to the system could occur. Once the mast is at 90°, all RCP functions are available.

There are two ways to raise the mast to 90°.

- Use the Auto-up feature (not available on the wireless HHRC).
- Press the “Mast Up”  button.

There are several advantages in using the Auto-up feature instead of the “Mast Up”  button to raise the mast to 90°:

- The Auto-up feature automatically moves the mast to 90°, whereas the “Mast Up”  method requires the operator to press the controls throughout the process.
- The Auto-up feature allows the system to check its switches and better determine the 90° position.
- The Auto-up feature automatically turns on the lights at 90°, whereas using the “Mast Up”  button does not.



The Auto-up feature is the quickest and most reliable method to raise the mast to 90° and turn on the lights. Using the Auto-up feature does not require the operator to stop the mast exactly at 90° before turning on the lights.

Two common operator errors can occur when the operator does not use the Auto-up feature:

1. On uneven ground, an operator may believe the mast has reached 90° and release the “Mast Up”  button too early. Then when the operator attempts to turn on the lights, the lights do not turn on as the 90° Switch is not active. If the operator used the Auto-up feature, the mast would unfold until it reached exactly 90° and then automatically turned on the lights.
2. During high winds, if an operator stops the mast before it is firmly seated at 90°, the mast may initially be at 90°, but be pushed off of 90° by the high winds. This could cause an error when the operator wants to use certain controller functions like panning the lights since the mast must be at 90° to pan the lights.

When using the “Mast Up”  button, press the button until the software stops the mast in order to ensure the mast has reached 90°.





3.5.1 Using the Auto-Up Feature

The Auto-up sequence can be aborted by pushing any of the buttons on the controller at any point during the Auto-up sequence. If the Auto-up sequence is aborted, the mast will stop and wait for input from the controller. “AutoUp” will be shown on the controller, and after the mast leaves the stowed position and begins moving toward 90° (takes about 2 seconds); the controller “Mast Down”  and “Mast Up”  LEDs will light.

To raise the mast to 90° using the Auto-up feature, press the “Mast Up”  button twice quickly in successive depressions (two depressions within a ½ second). The mast will raise to 90° and automatically turn on all the lights. The mast will not extend upward by itself, but will await further operator input from the controller.



3.5.2 Using the Mast Up Button

Raise the mast to 90° using the “Mast Up”  button as follows:

1. Press the “Mast Up”  button until the mast is at 90°. Press the button until the software stops the mast to ensure 90° has been reached.
2. Release the “Mast Up”  button when the additional controller LEDs like “Tilt Down”  and “Pan Right”  light.

3.6 Extending the Mast





The mast can be extended to full or partial height. To extend the mast when it is at 90°, press the “Mast Up”  button until the mast reaches the desired height.

Pushing the “Mast Up”  button will cause the mast to rise until the “Mast Up”  button is released, or the mast reaches its maximum extended height. If the “Mast Up”  button is not released, the mast will reach its fully extended height, the air pressure will rise to 20 lb., and then the exhaust valve will open and exhaust any more air that enters the mast, leaving the mast at its maximum extended height.



3.7 Controlling the Lights

The lights can be turned on and off from the controller when at the 90° position or while extended. At the 90° position, the RCP and lights are enabled. From the 90° position, the RCP can initially position the lights down and to the right only. Once the RCP reaches a 350° position, the RCP can only rotate back in the other direction.

To pan and tilt the lights:

- Holding the “Tilt Down”  button turns the lights down and all the way around to 350°.
- Holding the “Tilt Up”  button, turns the lights back in the other direction.
- Holding the “Pan Right”  button turns the lights to the right.
- Holding the “Pan Left”  button turns the lights to the left.
- Pressing the “Lights”  button turns the lights on and off.

3.8 Lowering the Mast

Once the mast has been extended, pressing the “Mast Down”  button will lower the mast. Continue to press the “Mast Down”  button until the mast reaches the desired height and then release the button.

3.9 Stowing the Mast



The “stowed” position is also called the “nested” position. The stowed position is the position of the mast when it is folded down and firmly seated in the saddle. The mast is considered stowed when the Mast Stowed Switch is closed, and the brief over current condition is met when the mast is driven into the saddle.

It is the responsibility of the customer to properly secure the payload for vehicle travel.

The mast can be stowed by using:

- Auto Stow[®]
- Mast Down
- Emergency Stow With Power
- Emergency Stow Without Power

The best method is to stow the mast with the Auto Stow[®] feature. It does not require the operator to stop the mast exactly in the saddle. The mast can be auto-stowed from any position including 90°, partially extended, or fully extended.

On NFPA systems, all power is removed after the mast is stowed. To operate the mast again on NFPA systems, the red “Start/Stop”  button must be turned. The green “NFPA Start”  button must then be pushed. This is a safety feature that prevents the mast from being inadvertently raised.

On Standard systems, power is still applied to the system after the mast is stowed and it is not required to turn the “Start/Stop”  button to operate the mast again. Since power is still applied, care must be taken to ensure the controller buttons are not accidentally hit.

3.9.1 Using the Auto Stow[®] Feature



To use the Auto Stow[®] feature:

1. Press the “Mast Down”  button twice quickly in successive depressions (two depressions within ½ second). The mast will pan and tilt the RCP to the home position, lower the mast to 90° (if not already there), turn off any lights, and stow the mast. This automatic sequence can be aborted by pushing any of the buttons on the controller at any point during the Auto Stow[®]. If a button is pressed, the mast will not stow by itself, and will await further operator input.
2. On an NFPA system, wait until all controller LEDs turn off. Any lit LEDs indicate that the mast is not stowed.
3. Visually inspect that the mast is properly stowed. Ensure that the payload will not bounce as the vehicle drives down the road.
4. Store any controllers so they will not be damaged during transportation.

3.9.2 Using the Mast Down Button

Another method used to stow the mast is to press the “Mast Down”  button on the controller. This method is not as reliable as using the Auto Stow[®] feature. Care must be taken to ensure that the operator does not release the button before the mast is completely stowed. If the mast is not completely stowed, equipment may be damaged during transportation.

To stow the mast using the “Mast Down”  button:

1. Press the “Mast Down”  button until the mast stops and the “Mast Down”  LED is turned off. The mast will lower to 90° (if not already there), then to the home position, and then stow the mast. Once stowed, the Mast Stowed Safety Interlock Contact signals it is safe to move the vehicle.
2. On an NFPA system, wait until all controller LEDs turn off. Any lit LEDs indicate that the mast is not stowed.
3. Visually inspect that the mast is properly stowed. Ensure that the payload will not bounce as the vehicle drives down the road.
4. Store any controllers so they will not be damaged during transportation.

3.9.3 Emergency Stow with Power

If the mast cannot be stowed using the Auto Stow[®] feature or “Mast Down”  button, the emergency stow button (S4) on the Base Board can be used to stow the mast if the following are both true:

- Power is still applied to the system.
- The actuator is still functional.

Pressing the emergency stow button causes the system to generate an “ERR 1,20” error. Errors cause the mast to automatically:

- Move the RCP to the home position (provided there are no electrical or mechanical issues with the RCP).
- Exhaust all air from the mast, which lowers the mast to 90°.

WARNING

Using the emergency stow button causes the actuator to lower the mast without regard to any faults, switches, or system interlocks. It is totally up to the operator to ensure safe operation during an emergency stow attempt.

Once the mast has lowered to 90°, pressing and holding S4 will drive the actuator to stow the mast. The mast will continue to lower and drive in the saddle until S4 is released.

To stow the mast using the emergency stow button:

1. Remove the left side cover (the side with the look-up light) if not already removed.
2. Tap S4 on the Base Board. Do not hold down S4; just press, then immediately release S4 once. This will cause the controller to show an “ERR 1,20”. The error will cause the RCP to go to its home position and exhaust all air from the mast.
3. Wait until all air has exhausted from the mast. The mast should now be retracted and in the 90° position.
4. Ensure that the RCP and lights are in the home position. If the RCP and lights are not in the home position, manually adjust the pan or tilt of the RCP. Before adjusting the RCP or lights, make sure that the lights have cooled completely. To adjust the pan, grasp the horizontal light shafts and rotate to perpendicular to the base. To adjust the tilt, grasp the top and bottom of the light, and slowly rotate the lights so they are face down.
5. Ensure that there are no obstructions in the path of the mast.

WARNING

When using the emergency stow button, normal operation switches are disabled. The mast can be overdriven into saddle and cause damage to the unit.

6. While observing the RCP, lights, and mast, press and hold S4 on the Base Board.

7. Ensure that the RCP and lights are properly positioned as the mast goes from 90° to the stowed position.
8. Immediately release the S4 button as soon as the RCP shaft is in the saddle.
9. Visually check that the mast is properly stowed. Ensure that the lights do not bounce as the vehicle drives on the road.

3.9.4 Emergency Stow without Power

If power is lost or an unrecoverable error occurs, the mast will automatically exhaust all air and lower to 90°. However, the mast will not return to its fully stowed, horizontal position. Since there is no power to run the actuator, the emergency stow button cannot be used and the mast must be stowed manually.

To manually stow:

1. Ensure all power has been disconnected from the system.
2. Adjust the pan and tilt, if necessary, to place the payload in the stow position. Ensure that the payload will not make contact with the saddle or mounting surface when the mast stows. If your system includes lights, make sure any lights have cooled completely before manually panning and tilting. Lights should be rotated so they will be facing down when the mast is stowed.
3. Remove the cover to access the actuator.
4. Remove the 6 mm hex head bolt on the end of the actuator cover (Figure 3-1).

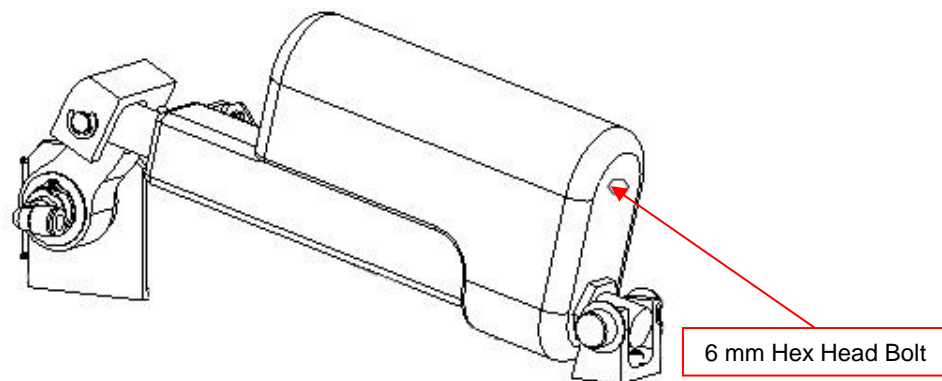

Figure 3-1 Hex Head Bolt Location

5. Place a long 6 mm hex head wrench into the hole to reach another 6 mm bolt. A socket hex head wrench may be used, but care must be taken not to damage the adjacent components.
6. Turn the hex head wrench clockwise to lower the mast. Lower the mast until it seats firmly in the saddle.
7. Replace the right side base cover.

(This page is intentionally left blank.)

Section 4 Maintenance and Adjustments

This section describes the routine maintenance and adjustment procedures required to keep your system operational.

⚠ WARNING

If manually lowering the mast, make sure all power has been disconnected from the system prior to manually lowering the mast.

4.1 Cleaning the System

Will-Burt pneumatic telescoping masts come from the factory pre-lubricated and require no scheduled maintenance under normal operating conditions. In extremely harsh environmental conditions, maintenance of the mast might be required.

Signs that cleaning and lubrication are needed can be:

- A noticeable gritty film on the exterior surfaces of the mast sections
- Erratic extension or retraction of the mast
- Noisy operation of the mast
- Sticking of one or more mast sections when mast is extending or retracting

⚠ WARNING

Make sure the lights are completely cool before attempting to clean the light lenses.

To clean the system:

1. While at 90°, wipe down the base using a soft cloth or sponge and a mild solution of soapy water.
2. Wipe down the RCP using a soft cloth or sponge and a mild solution of soapy water.
3. Clean the light lenses using a soft cloth and standard glass cleaner.

⚠ WARNING

A pneumatic telescoping mast is a pressurized vessel. Caution must be exercised to stay clear when the mast is being extended. Do not lean directly over the mast. Proper eye protection should be worn when working on the mast.

After cleaning the mast, if the mast is in extremely harsh environmental conditions, lubricate the mast with TMD Mast Lubricant (P/N: 900600). TMD Mast Lubricant is specifically formulated for cold weather use, but is also suitable for year around use. Regular winter maintenance and frequent use of TMD Mast Lubricant should significantly reduce the potential for mast freeze-ups.

To clean and lubricate the mast:

1. Reduce the regulator (Figure 4-1) setting such that it pressurizes the mast to between 5 and 10 PSIG. Pull up on the regulator cap and rotate counterclockwise. Push cap down to lock into place.

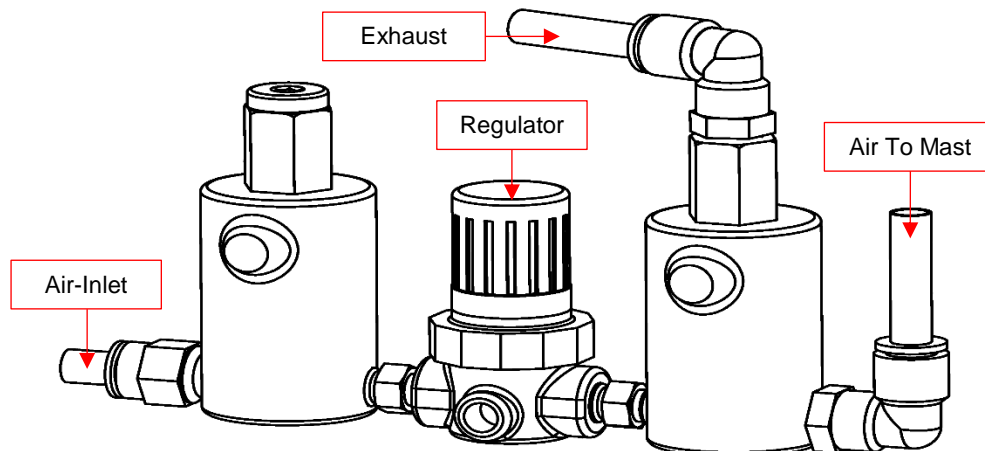



Figure 4-1 Regulator

2. While at the 90° position, have one person press the “Mast Up”  button to slowly pressurize the mast just enough to extend the desired mast section. A second person may have to hold down the larger mast section collars to ensure the desired tube extends. Release “Mast Up”  button as soon as the desired mast section is fully exposed.

⚠ WARNING

Fire Hazard! Cleaning solvent, used for maintenance, is flammable and can be explosive resulting in death or serious injury. Do not smoke. Use cleaning solvent in a well-ventilated area. Keep cleaning solvent away from ignition sources. Always store cleaning solvent in the proper marked container.

3. Wipe down the desired mast section using a non-abrasive cleanser or solvent such as lacquer thinner. Do not allow the cleaning fluid or solvent to run down inside the collar.
4. Repeat steps two and three for the next larger mast section.



⚠ WARNING

Do not lubricate the exterior of the mast. This will cause the lubricant to attract dust and contaminants from the air.

5. Inject approximately ½ oz. of TMD Mast Lubricant or lightweight machine oil into the weep hole (drain) of each exposed mast section. The weep holes are located approximately 10" below the collar on each tube except the top tube.

⚠ WARNING

Keep hands clear of the descending collars while the mast is being lowered to avoid pinching.









6. Using the “Mast Down”  button, lower the mast to 90°.
7. Wait several minutes to allow the lubricant to settle and spread around the wear ring and seal at the bottom of each mast section.
8. Using the “Mast Up”  button, extend the mast one section at a time. For each section wipe off any excess lubricant which flows out the weep holes.

4.2 Functional Test

To test the functionality of the system, preform the following tests.

4.2.1 Emergency Circuit Test

To test the emergency circuit, power up the system and operate the system, and then press the “Start/Stop”  button at the following stages and check if the system is stopped and de-energized:

- Mast Up  (Actuator active – mast going from 0° to 90°)
- Mast Up  (Up valve active – actual telescoping mast raising in height)
- Light Pan ( and )
- Light Tilt ( and )
- Mast Down  (Down valve active – telescopic mast lowering in height)
- Mast Down  (Actuator active – mast going from 90° to 0°)



4.2.2 Brake Function Test (Standard Only)









To test the brake function in Standard (or non-NFPA) systems, check the following:

1. If the vehicle brake signal is off, the system should not operate.
2. If the vehicle brake is on, the system should be able to operate.
3. During operation, if the vehicle brake signal goes off, the system should shut down and:
 - Stow automatically (units in Standard [non-NFPA] mode)
 - Exhaust air (units in NFPA mode)

4.2.3 Function Circuit Test

To test the limit switches:

1. Pan Left: Hold the “Pan Left”  button on the controller to let the light pan to left side. The light will turn almost one circle (less than 360°) and the motor will stop. After fully panning to the left, only the “Pan Right”  button on the controller is active; the indicator for the “Pan Left”  button on the controller should be off.

2. Pan Right: Hold the “Pan Right”  button on the controller to let the light pan to right side. The light will turn back to the original home position and the motor will stop. At the home position, only the “Pan Left”  button on the controller is active; the indicator for the “Pan Right”  button on the controller should be off.
3. Tilt Down: Hold the “Tilt Down”  button on the controller to let the light tilt down. The light will tilt almost one circle (less than 360°) and the motor will stop. After fully tilting down, only the “Tilt Up”  button on the controller is active; the indicator for the “Tilt Down”  button on the controller should be off.
4. Tilt Up: Hold the “Tilt Up”  button on the controller to let the light tilt up. The light will tilt back to the original home position and the motor will stop. At the home position, only the “Tilt Down”  button on the controller is active; the indicator for the “Tilt Up”  button on the controller should be off.
5. Mast Down and Mast Not Down: Power on the system. Using an external magnet to attach the top magnet switch, and observe the LED D3 and D4 on the Base Board. If the sensor is active, D3 should be on and D4 off, otherwise D4 should be on and D3 off.

4.3 Adjusting the 90° and Mast Stowed Switches

Before delivery of a new system, all switches are properly set and tested and normally no switch adjustment is necessary. However, if a switch needs adjusted, for example if the actuator was replaced, follow the steps outlined in this section to make the adjustment.

4.3.1 Diagnostic LEDs

Table 4-1 charts the colors of the relevant diagnostic LEDs for the various mast positions. An example of the diagnostic LEDs showing the mast in the stowed position is shown in Figure 4-2. These diagnostic LEDs can be used to help determine if an adjustment is necessary, for example if D7 / D8 shows Yellow when the mast is supposed to be stowed. They are also useful in assisting to determine when the switches have been properly adjusted.

Table 4-1 Mast Positions Shown by Diagnostic LEDs

	D7 / D8	D10 / D11	D13 / D14
Mast Stowed	Green	Green	Green
Mast Between 0° and 90°	Yellow	Green	Green
Mast at 90°	Yellow	Yellow	Green
Mast Extended	Yellow	Yellow	Yellow

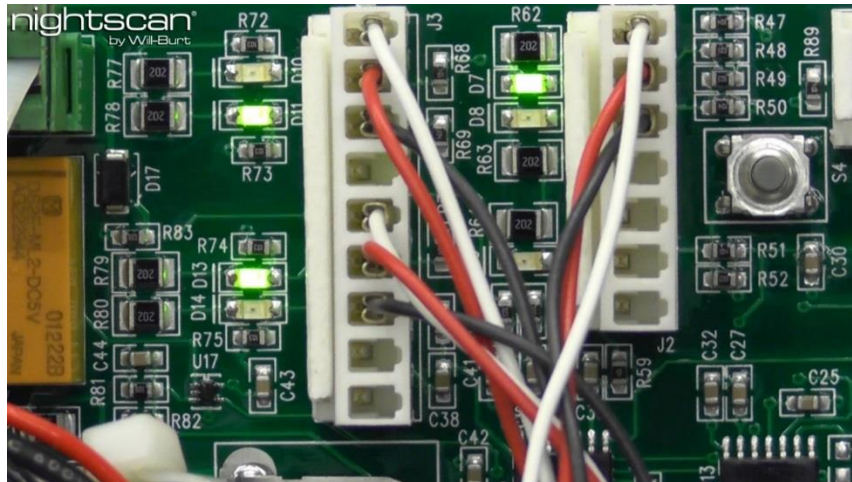



Figure 4-2 Diagnostic LEDs D7/D8, D10/D11, and D13/D14 Displaying the All Green Stowed Position

4.3.2 Adjusting the 90° Switch

The 90° Switch (Figure 4-3) senses when the mast is at 90° by checking the position of the actuator. When the mast is being raised from the stowed position and the 90° Switch is sensed, power to the actuator is removed thus allowing the mast to remain at 90°. The mast will not extend and the RCP will not function if the mast is not at 90°.

To adjust the 90° Switch:

1. Make certain that the base is level.
2. Remove the base cover to access the switches and Base Board.
3. Loosen the locknuts to adjust the switch.
4. Raise the mast to 90° by holding the “Mast Up”  button until the mast is at 90°. Do not use the Auto-up feature to raise the mast to 90°.
5. Check that the mast is at 90° by using a level, ensuring that the mast is square to the sheet metal side plate on the base. A value range of 89.5 to 90.5° is acceptable.
6. Adjust the 90° Switch until it senses the actuator. This will be indicated by the diagnostic LEDs on the Base Board (Figure 4-2).
7. Secure the switch in position using the locknuts.
8. Raise and lower the mast several times, checking that the mast is plumb each time, and adjust the switch if necessary.
9. Replace the cover.

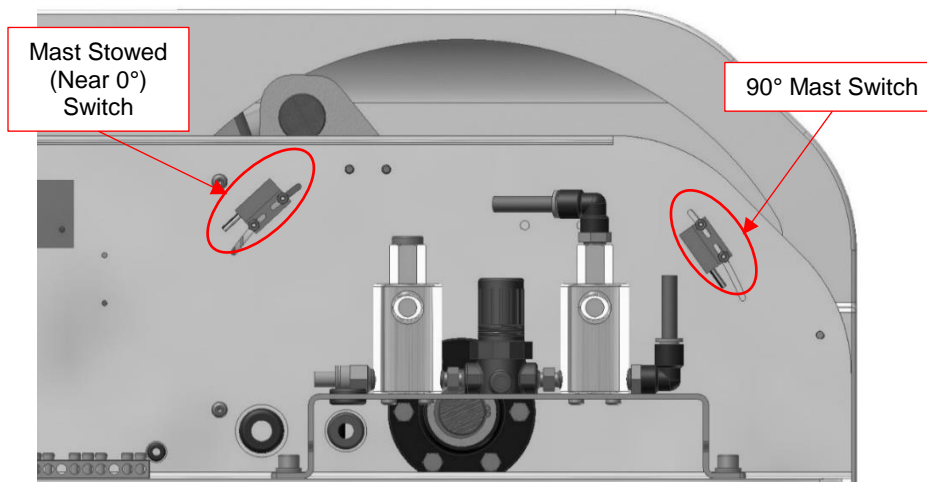



Figure 4-3 Mast Stowed and 90° Mast Switch

4.3.3 Adjusting the Mast Stowed Switch

The Mast Stowed (near 0°) Switch (Figure 4-3) senses that the mast is in the saddle upon power up, and when the mast is nearing the saddle during stowing. The circuit then looks for a pre-determined current rise (for a maximum of 0.5 seconds) to indicate a solid nesting before shutting off.





To adjust the Mast Stowed Switch:

1. Make certain that the base is level.
2. Remove the base cover to access the switches and Base Board.
3. Raise the mast to gain access to the Mast Stowed Switch.
4. Loosen the locknuts to adjust the switch.
5. Lower the mast to the stowed position by holding the “Mast Down”  button until the mast is stowed. Immediately release the “Mast Down”  button when the mast is stowed. If you drive the mast too far into the saddle, you may receive a “1,04” error (excessive amp draw during actuator decline). Do not use the Auto Stow[®] feature to stow the mast.
6. Check that the mast is properly stowed. This will be indicated by the diagnostic LEDs on the Base Board. As the mast comes down D11 and D13 will be green, and D7 will be yellow. Once stowed, D7 will also turn green (Figure 4-2).
7. Raise the mast to gain access to the Mast Stowed Switch.
8. Secure the switch in position by using the locknuts.
9. Raise and lower the mast several times, checking that the mast stows each time, and adjust the switch if necessary.
10. Replace the cover.

4.4 Adjusting the Magnetic Down Switch

The Magnetic Down Switch is band-clamped to the base tube. This switch senses a magnet in the top tube when the mast is at 90°, or stowed, but not extended. The magnet is located in a recess at the bottom of the top tube and is not visible from outside the tube. If the Magnetic Down Switch is misadjusted, the mast may give an error code upon power up, or may not stow from 90°. When adjusting the Magnetic Down Switch, ensure that the mast is at 90° or stowed with all collars stacked and no gap between them.

Before delivery of a new system, all switches are properly set and tested and normally no switch adjustment is necessary. However, if an adjustment is required, adjust as follows:

1. Loosen the band-clamp that holds the Magnetic Down Switch and lower the clamp to the bottom of the mast.
2. While observing the Base Board diagnostic “Mast Down”  LED, slowly move the band-clamp up until the “Mast Down”  LED turns green.
3. To test:
 - a. Initiate the mast.
 - b. Press the “Mast Down”  button on the controller until the mast stows. If the mast does not stow, repeat steps one and two several more times or until the mast stows.
4. If repeated adjustments do not succeed, use a small piece of steel or iron filings to locate the magnet in the tube and move the Banded Magnetic Switch to the magnet's location.
5. If the mast still will not stow, hold a magnet up to the Banded Magnetic Switch. Press the “Mast Down”  button and ensure that the mast begins to stow:
6. If the mast stows, repeat the switch adjustment steps above until the switch senses the magnet.
7. If the mast does not stow, check the wiring to the Base Board for loose or disconnected wires. See the wiring diagrams for the system. If the wiring is intact, replace the magnetic switch.

4.5 Adjusting the RCP Home Position

The RCP home position is the position of the RCP and lights where the light bars are parallel to the axis of the mast and the lights are facing down when stowed. If the RCP home position is set properly, when being stowed the RCP shafts should contact the saddle simultaneously. The home position is established by setting small flags in the RCP that engage photo interrupters on the RCP board. Adjusting the RCP home position should be done indoors. Adjusting the home position outside can cause improper RCP operation due to sunlight reaching the photosensors. Before delivery of a new system, the RCP home position is tested and normally no adjustment is necessary.

⚠ WARNING

Make sure all power has been disconnected from the system prior to manually lowering mast. This can be accomplished by turning all breakers to the OFF position.

If an adjustment is required, adjust the RCP home position as follows:

1. Disconnect all light power to the system.
2. Initiate the mast raise the mast to the 90° position. The controller should show both left and right tilt up functions, and the pan left function as available.
3. Remove the RCP cover to access the flags. The flags are attached to the timing rings on the horizontal and vertical shaft gears (Figure 4-4). Each timing ring has two set screws that must be loosened. It may be necessary to loosen one in each, then pan and tilt the unit to access the others. **Note:** The flags have sharp edges which may cause cuts.

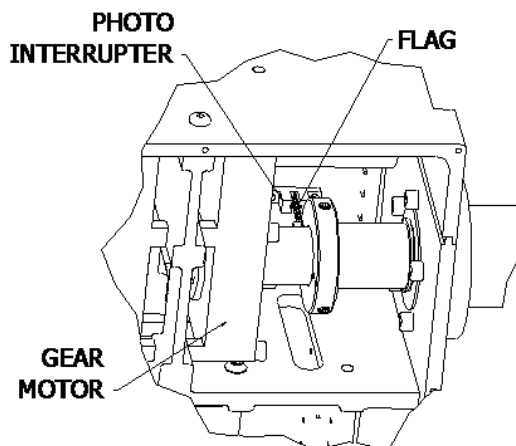

Figure 4-4 Photo Interrupter and Flag

4. Once the set screws are loose, pan (↔ and ↔) and tilt (↕ and ↙) the unit to the correct home position. Be careful that the flags do not come into contact when panning and tilting, or they may be bent.

5. It is important that the flags engage the correct photo interrupter when setting the home position (Figure 4-5). Turn the timing ring on the right horizontal shaft such that it rotates down toward the upper photo interrupter. As you approach the interrupter, watch the controller. As soon as the right tilt down LED goes out, stop rotating the ring and tighten the set screw. Repeat on the left horizontal shaft.

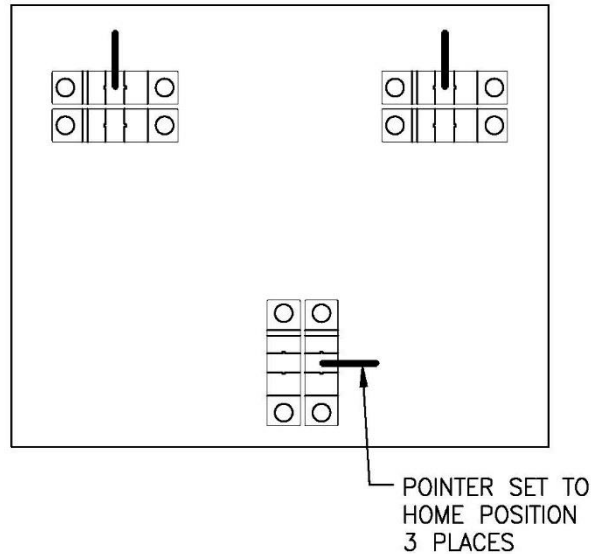



Figure 4-5 RCP Home Position

6. To set the pan home position, turn the timing ring counterclockwise (looking from above the RCP) until the pan right LED goes out. Tighten the set screw to secure the ring.
7. Pan and tilt the unit until the second set screw in each ring is accessible. Tighten each set screw.
8. Stow the mast, watching for the RCP and lights to become oriented as described in the beginning of this section.
9. Turn the red "Start/Stop"  button and raise the mast to 90°. Replace the RCP cover.

(This page is intentionally left blank.)

Section 5 Reference Information

This section describes reference information for your system.

5.1 DIP Switch Definitions

DIP Switches on the Base Board and the RCP board are set at the factory and normally do not have to be changed. The DIP Switches on the Base Board define the warning light signal, NFPA versus Standard mode, if an RCP is present, and if the mast is a Vertical or a fold-down. The RCP DIP Switches define if the system should stow automatically while on a fault, if the RCP is a Profiler unit, and if the system stows before or while lowering. For additional information on the DIP Switches and their settings, see the drawings in Section 8.

Note: The controls check the status of the DIP switches only during initialization. After flipping a DIP switch, the system will need restarted for the change to take effect.

5.2 Strobe/Beacon Light

The optional strobe/beacon light (Figure 5-1) provides visibility and safety by mounting on top the RCP and brightly showing the height of the mast. The strobe/beacon light can be used at any voltage from 12 to 48 VDC. The strobe/beacon lights are available in amber, blue, clear, red, and green. LED strobe lights are also available. The strobe/beacon light can be turned on by pressing the “Auxiliary Light”  controller button when the mast is at 90° or extended. Pressing the button again would turn the strobe/beacon light off. When ordered, the optional strobe/beacon light is shipped installed and no additional wiring is required.



Figure 5-1 Optional Strobe/Beacon Light

5.3 Nycoil (Optional)

The Nycoil Cable Conduit (Figure 5-2) is an optional external coiled hose used to house electrical wiring, antenna RF, and positioner cables.

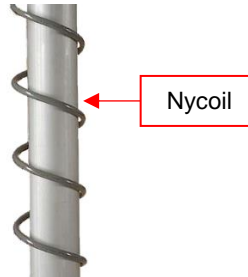

Figure 5-2 Nycoil Cable

Nycoil cables come in a variety of sizes. Depending on the system being used, some restrictions on the size of the Nycoil may occur.

The standard sizes for the Nycoil are:

- ½ inch inside diameter of the cable with the outside diameter of the coil being 8 inch
- ¾ inch inside diameter of the cable with the outside diameter of the coil being 13 inch

Consult engineering on specific applications for other Nycoil sizes.

5.4 Will-Burt Mast Oil MSDS Sheet

MATERIAL SAFETY DATA SHEET (MSDS)

The Will-Burt Company Orrville, Ohio 330-682-7015

SECTION 1: PRODUCT AND COMPANY IDENTIFICATION

Etna Products Inc.
16824 Park Circle Drive
Chagrin Falls, Ohio 44022

Company Phone Number: (440)-543-9845
Emergency Phone Number: (800)-229-3862
CHEMTREC Phone Number: (800)-424-9300

Product Name: Masterdraw B985 B
Product Number: 000826
Issue Date: 02/03/2014
Supersedes Date: 09/22/2009

Will-Burt Product Name: Mast Lubrication
Will-Burt Part Number: 900600

SECTION 2: HAZARDS IDENTIFICATION

EMERGENCY OVERVIEW

Appearance / odor: Transparent Blue liquid with a petroleum oil odor
WARNING: May cause slight to mild irritation of the skin, eyes and mucus membranes with repeated exposure.
Fire: Will burn in a fire.
Likely Routes of Exposure: Skin contact, Eye contact, Inhalation
Skin: Prolonged or repeated exposure may cause irritation or oil acne
Eyes: Contact with the eyes may cause temporary irritation
Inhalation: Vapors generated at high temperatures or oil mist may cause mild irritation of the mucus membranes.
Ingestion: Considered no more than slightly toxic if swallowed.
Medical Conditions Aggravated by Exposure: Pre-existing skin and respiratory disorders.
This product does not contain any SARA 313 reportable compounds
This product does not contain any carcinogens as defined by OSHA, NTP and IARC at greater than 0.1%
Hazardous Materials Identification System Rating (HMIS®) 110 C

SECTION 3: COMPOSITION / INFORMATION ON INGREDIENTS

The table below will only list hazardous ingredients. If the table below is blank none are present.

Component	Chemical Abstracts Number (CAS)	% by Weight
None		

SECTION 4: FIRST AID MEASURES

Skin Contact: Remove contaminated clothing and wash with soap and water. If irritation occurs get medical attention.
Eye Contact: Flush with water for 15 minutes. If irritation occurs get medical attention.
Inhalation: Remove victim to fresh air and provide oxygen if breathing is difficult. Get medical attention.
Ingestion: Do not induce vomiting. Get medical attention.

SECTION 5: FIRE FIGHTING MEASURES

Use water, fog, foam, dry chemical or CO2. Do not use a direct stream of water. Product may float and can be reignited on the surface of the water.
Unusual Fire and Explosive Hazards: None
Products of Combustion: Highly dependent on combustion conditions. Mixture of air borne solids, liquid and gases evolve upon decomposition by heat or combustion. CO2 and other organic compounds may be formed during combustion.
Protection of Firefighters: Cool fire exposed surfaces. Do not enter fire space without proper protective equipment including full fire fighting turnout gear and a NIOSH approved self-contained breathing apparatus.

SECTION 6: ACCIDENTAL RELEASES

Personal Precautions: Use personal protection recommended in Section 8 and by the HIMS Rating.
Environmental Precautions: Recover free product. Prevent product from entering sewers or waterways by diking or impounding. Advise authorities if product enters waterways or extensive land areas.
Methods of Containment: Use sand, earth or other suitable absorbent to the spill.
Methods of Clean-up: Remove free and absorbed material from the spill area. Dispose of recovered material and residue in compliance with all federal, state and local regulations.

SECTION 7: HANDLING AND STORAGE

Handling: Keep containers away from heat, open flame or strong oxidants. Use personal protection recommended in Section 8 and by the HIMS Rating.
Storage: Store inside away from heat, open flame and strong oxidants. Keep containers closed when not in use.

SECTION 8: EXPOSURE CONTROL / PERSONAL PROTECTION

Occupational Exposure Guidelines
OSHA PEL / TWA: 5 mg / M3
OSHA PEL / Ceiling: N/E
ACGIH TLV / TWA: 5 mg / M3
ACGIH TLV / STEL: 10 mg / M3
Based on: oil mist

Engineering Controls: Provide local exhaust ventilation to prevent exceeding recommended exposure limits. Controls are required only to capture vapor, mist or fumes.

Eye and Face Protection: Use safety glasses or goggles to prevent eye contact.

Skin Protection: Use chemically resistant gloves to avoid prolonged skin contact. Use chemically resistant apron as necessary.

Respiratory Protection: As needed to prevent over exposure to mist or fumes. Use NIOSH approved chemical mist and organic vapor respirator.

General Hygiene Considerations: Wash thoroughly after handling. Wash with soap and water prior to using toilet facilities, eating, drinking or smoking.

SECTION 9: PHYSICAL AND CHEMICAL PROPERTIES

Boiling Point:	> 500 F
Specific Gravity @ 15.6 °C:	.87
Vapor Pressure:	Unknown
% Volatile / % VOC:	Unknown
Vapor Density (Air = 1):	Unknown
Evaporation Rate (N-BA=1):	> 1
Solubility in Water:	Nil
pH:	Not available
Reactivity in Water:	Nil
Appearance:	Transparent Blue liquid
Odor:	Petroleum odor
Flashpoint:	> 300 F
Flammable Limits (In air % by Volume):	Upper: Unknown Lower: Unknown
Auto Ignition:	Unknown

SECTION 10: STABILITY AND REACTIVITY

Stability: Stable

Conditions to Avoid: Strong oxidants, heat, sparks and open flames

Hazardous Polymerization: Will not occur

Incompatibility: Strong oxidants

Decomposition Products: Mixture of air borne solids, liquid and gases evolve upon decomposition by heat or combustion.

SECTION 11: TOXICOLOGY INFORMATION

ACCUTE EFFECTS

Oral LD₅₀ Not established

Dermal LD₅₀ Not established

Inhalation LD₅₀ Not established

CHRONIC EFFECTS

None

SECTION 12: ECOLOGICAL INFORMATION

Not available

SECTION 13: DISPOSAL INFORMATION

The material is non hazardous, dispose of material in compliance with all federal, state and local regulations.

SECTION 14: TRANSPORTATION INFORMATION

Proper shipping Description: None

Consider the product to be non-hazardous. No special labeling is required by the Department of Transportation.

SECTION 15: REGULATORY INFORMATION

Global Inventories

TSCA: United States	The ingredients of this product are included
DSL: Canada	The ingredients of this product are included
EINECS: European Union	The ingredients of this product are included

SARA 313 Information:

Component	CAS #	% by weight
None		

WHMIS: Canadian Workplace Hazardous Material Information System:

SECTION 16: OTHER INFORMATION

Prepared by: The Will-Burt Company Technical Department

The information contained herein is based on the data available to us and is believed to be correct. The Will-Burt Company does not warrant or guarantee their accuracy or reliability and The Will-Burt Company shall not be liable for any loss or damage arising out of the use thereof. The information and recommendations are offered for the user's consideration and examination and it is the user's responsibility to satisfy oneself as to the suitability and completeness of this information for their own particular use.

February 3, 2014

Section 6 Troubleshooting

This section describes the troubleshooting of your system. The CD that contains this manual will also contain a software Night Scan Product Troubleshooting Guide.

6.1 Troubleshooting Electrical

This section includes a list of warning and error codes and their potential causes. Warning codes do not halt the situation, but let you know of potential issues. Error codes point out problems and usually inhibit operation to prevent potential damage. These codes are shown on the status light on the Base Board. For example, an error of 3,07 would be shown on the status light as three flashes, pause, seven flashes. Additionally, if the controller for your system has a display, errors and warnings will typically be shown there. For more extensive information, see the Night Scan Product Troubleshooting Guide.

Table 6-1 Base Codes

Message	Meaning	Root Issue	Potential Cause
WRN 1,04	Look-Up light is burned out.	The control circuit is not sensing the look-up light current.	Look-up light is burned out or disconnected somehow.
WRN 1,05	Well cover switches indicate closed when they should be open. This stops all vertical movement of the mast to prevent damage to the mast, covers, or load.	Well cover switches indicate closed when they should be open.	Wiring error, or defective switch.
WRN 1.06	RCP Stow (Vertical, upper mag switch) – Sensor State Error.	Switch outputs are valid (opposite), but switch shows wrong polarity for nested state.	Defective mag switch, defective base board.
WRN 1,07 (Vertical Only)	At power up, the lower mag switch is indicating “up” (yellow) when it should be “down” (green). If you ignore the warning and continue, the mast will go up, but will shut down after a few seconds with an ERR 1,14.	The lower mag switch needs to be adjusted. D13 should be green when it “sees” the magnet	Wiring error, defective mag switch.
1,01	Mast Down (mag switch) - Sensor State Error.	This is only checked at power up, if stowed. Sensor outputs are O.K., but it is indicating that the mast is extended (not down).	1. The magnetic sensor is not being energized or is defective. 2. Mag switch out of position.
1,02	Mast Stowed (near 0°) – Sensor Output Error	Sensor outputs are bad.	Defective sensor, defective board
1,03	Mast Stowed (near 0°) – Sensor State Error.	Sensor outputs are O.K., but sensor shows wrong polarity for nested state. The board remembers where it was (0° or 90°) when it was shut off, and this time it powered up, it's sensing the opposite condition.	Base board was changed or software was updated with the mast at 90°.

Message	Meaning	Root Issue	Potential Cause
1,04	Excessive amp draw during actuator decline	Current sensor indicating it has exceeded: (12v systems) 10A for 100ms (24v systems) 6.0 amps AND less than 10 amps for (100 msec)	If mast stops at ~70° and issues error, replace Base Board. Current sense circuit has failed. If error occurs during nesting, check LED D7 "MAST STOWED (near 0°)". Once the sensor "sees" the magnet, it allows 0.5 sec to see the (nesting) current rise. If the circuit does not see the sensor, it does not look for nesting current to shut down. It will keep driving into the saddle and then issue a 1,04. Re-adjust Near 0° sensor. Bad actuator – AC component in current wave shape due to internal mechanical problem. Replace actuator.
1,05	Well Open (Vertical with well cover) - Switch Output Error	Sensor outputs are bad.	Defective switch or wiring error. Refer to System Wiring Diagram.
1,06	Well Open (vertical with well cover) - Switch State Error.	Switch outputs are O.K., but show wrong polarity for closed state.	Well cover open or wiring error. System is expecting the well cover to be closed at power-up.
1,07	Microprocessor Error	No successful poll / response communication for 250ms.	
1,08	Internal firmware detected error.	Internal state machine logic has detected an invalid state transition. Firmware logic error.	
1,09	Initiate Pushbutton input error.	Init input has remained active for 5 seconds. Input is stuck, or has been hot-wired.	1. Unit is in NFPA mode and connected to a Non-NFPA J-box. (Note: if the unit is in Non-NFPA mode and connected to an NFPA junction box, the unit will look normal (UP led on HHRC on), but will not respond to the HHRC. The software is expecting to see the init signal always on. No error message is generated). 2. Wiring short in the control cable or defective switch/wiring in the junction box.
1,10	Memory Error	Memory Error	Memory Error
1,11	Actuator current has unexpectedly stopped	During decline, the Base board senses actuator current. After the "Near 0°" sensor is detected, it is expecting to see the current level rise before it stops. This error indicates the sensed current has stopped before nesting.	If it occurs near the nested position: Actuator has reached its internal stop before nesting completed, most likely saddle too low or saddle not secured causing sideways movement when nesting.

Message	Meaning	Root Issue	Potential Cause
1,12	Sensor Output Error Roof-mount - Actuator at 90° magnetic sensor Vertical - Upper magnetic sensor switch	Sensor outputs are bad.	Wiring error, faulty sensor (Vertical only) mag switch positioning. Note: Sensor is only active as mast tube magnet goes by. Software watches for direction of travel and sensor activation to determine if mast is "up" or "down".
1,13	RCP STOWED magnetic sensor – Sensor Output Error (Upper magnetic sensor on Vertical)	Sensor outputs are bad.	Wiring problem, defective magnetic sensor.
1,14	Mast Down (lower magnetic sensor) 1. Sensor Output Error 2. Sensor State Error	1. Sensor outputs bad. They have not been opposite for >250ms. or 2. Mast was told to go up, and the sensor indicates it did not move after 8 seconds (v7.2), or 15 seconds (v7.3). 3. Sensor is not seeing magnet when mast is fully retracted.	1. There may be a wiring problem, or a defective magnetic sensor. or 2. Defective magnetic sensor, air supply inadequate, or external magnet affecting sensor. 3. Sensor not seeing magnet - sensor needs to be re-aligned.
1,15	At 90° (Actuator) - Sensor State Error	Checked at power up after stowing. Sensor outputs are O.K., but sensor shows wrong polarity for nested state.	Board was changed or updated while the mast was at 90°.
1,17	Well Closed (Vertical with well cover) - Switch Output Error.	Sensor outputs are bad.	D7 Green = Closed D8 Yellow = Not Closed
1,18	Well Closed (Vertical with well cover) – Sensor State Error	Switch outputs are O.K., but show wrong polarity for Well Closed.	Switch wiring, defective switch, board.
1,19	Both Near 0° and 90° - Sensor State Error	Both the Nested LS and the 90° LS have been detected active at the same time. This is an invalid condition, and indicates a problem with one or both sensors.	Both sensors indicate proximity, one may be bad.
1,20	Forced Stow has been activated	This fault is set when the Forced Stow switch is activated to assure the system is not in normal operation during the forced stow operation.	Forced Stow button has been activated

Table 6-2 RCP and Positioner Codes

Message	Meaning	Root Issue	Potential Cause
WRN 2,04	Single-tilt - Tilt Stuck Dual-tilt - Left Tilt Stuck	Checked only when moving out of a limit position. The software indicates the state of the (left) tilt photosensor has not changed even though the motor has been told to move for more than 1/2 second.	Something is preventing movement of left tilt mechanism, the motor is defective, or the RCP board is defective.
WRN 2,05	Right Tilt Stuck	Checked only when moving out of a limit position. The software indicates the state of the right tilt photosensor has not changed even though the motor has been told to move for more than 1/2 second.	Something is preventing movement of right tilt mechanism, the motor is defective, or the RCP board is defective.
WRN 2,06	Pan Stuck	Checked only when moving out of a limit position. The software indicates the state of the pan photosensor has not changed even though the motor has been told to move for more than 1/2 second.	Something is preventing movement of pan mechanism, the motor is defective, or the RCP board is defective.
2,01	Pan Limit Overlap	The software indicates both pan photosensors are blocked simultaneously.	Foreign material in one of the photosensors or faulty photosensor.
2,03 (Positioner Only)	TILT pot stuck	No movement detected in expected direction for 2.0 seconds	Soft stops are not set, something is preventing the sense voltage (pot) movement, the motor is defective, the sense voltage is going the wrong way (miswire), or the P/T drive board is defective.
2,04 (Positioner Only)	PAN pot stuck		
2,07	Communication Timeout	The RCP or P-T Drive board has not sent out communications recently.	Bad board or connection in communications link.
2,08	Microprocessor error	The RCP board has sent an invalid message.	Indicates a software problem.
2,09 (RCP Only)	(Left) Tilt Up wrap around	The software indicates the same photosensor was made before the opposite limit photosensor was made to stop rotation. This indicates wrap around.	1. The flag that interrupts the light may need to be adjusted to go deeper into the photocell. 2. The limit photosensor is defective
2,10 (RCP Only)	(Left) Tilt Down wrap around		
2,09 (Positioner Only)	Pan Pot Failure	The Positioner software indicates the pot feedback voltage is out of acceptable operating range.	Defective pot, incorrect wiring, bad connection, defective P-T board.
2,10 (Positioner Only)	Tilt Pot Failure		
2,11	2,11 Right Tilt Up wrap around	The software indicates the same photosensor was made before the opposite limit photosensor was made to stop rotation. This indicates wrap around.	1. The flag that interrupts the light may need to be adjusted to go deeper into the photocell. 2. The limit photosensor is defective
2,12	2,12 Right Tilt Down wrap around		

Message	Meaning	Root Issue	Potential Cause
2,13	2,13 Pan Right wrap around	The software indicates the same photosensor was made before the opposite limit photosensor was made to stop rotation. This indicates wrap around.	The limit photosensor is defective.
2,14	2,14 Pan Left wrap around		
2,15	Left Tilt Limit Overlap	The software indicates both tilt photosensors appear to be blocked simultaneously.	Foreign material in one of the photosensors or faulty photosensor.
2,16	Right Tilt Limit Overlap		

Table 6-3 HHRC Codes

Message	Meaning	Root Issue	Potential Cause
WRN 3,02	Dual HHRC simultaneous inputs	<p>Two HHRCs are sending commands simultaneously.</p> <p>If commands are not conflicting, they will be allowed (Base Board decides).</p> <p>If commands are conflicting, no action/movement will be allowed by the Base Board.</p> <p>Warning appears regardless of conflicting or not conflicting to alert operators that someone else is trying to operate the unit simultaneously.</p>	
3,07	Unrecoverable Communication Error	<p>The display board in the HHRC or PMRC has power, but the Base Board is not communicating with it. It may be caused by the HHRC, Base Board, RCP Board, or any other device that is using the RS-485 communication lines in the system.</p> <p>On an error, the Base Board stops the program, sends out the error code to the display devices and 'flashes' the code on the Base Board LED. Because one error can cause others to follow, the only code that is displayed/flashed is the first one that occurs. Other errors may happen after that, but they are not displayed. The idea is to show the actual initial problem, rather than any potentially confusing follow-on errors.</p>	Defective HHRC or defective base board. Bad or improper connection in communications link, or HHRC is not properly powered. Check continuity of the data lines from the DC power cable connector to the HHRC connector. Refer to System schematic. Also check that the shield in the junction box has a good electrical connection to the electronics common at one end or the other, but not both.
3,08	Microprocessor Error	Internal firmware detected error.	Replace HHRC or HHRC Display pcb.
3,09	RF module Error	Wireless Transmitter/Receiver did not properly initialize.	Return HHRC to factory for repair.

Table 6-4 Wireless J-Box and Wireless HHRC Codes

Message	Meaning	Root Issue	Potential Cause
8,07	Unrecoverable communication error	No successful poll / response communication for 250ms.	J-Box is not 'talking' to any other board. Check Base Board flashes and HHRC display for x,07.
8,08	Internal firmware detected error	Internal state machine logic has detected an invalid state transition.	Firmware logic error.
8,09	RF module error	XBee plug-in module did not properly initialize.	Bad module.
8,10	Memory Error	Memory Error	
8,11	HHRC power up negotiation failed	<p>Unit could not establish communication with any HHRC (wired or wireless) when the NS 3.0 / 4.5 was powered up.</p> <p>Panel Mount = unit 3, Wireless HHRC = unit 6, J-Box = unit 8.</p> <p>System can have a panel mount remote and an HHRC, or 2 HHRCs, but never 3 remote units.</p> <p>Negotiation happens every time the Base unit is powered up w/push-pull switch.</p>	Wireless HHRC is not plugged in during "Pull to Start" power-up.
8,12	In-system reprogramming failed	Dip-switch activated in-system reprogramming of attached devices was not able to successfully complete.	

6.2 Troubleshooting Mechanical Symptoms

This section describes mechanical troubleshooting of your system.

Table 6-5 lists some problems that may be observed, but may not generate an error or warning code on the controller.

Table 6-5 Mechanical Symptoms and Troubleshooting Sequence

Symptom	Root Issue	Troubleshooting Sequence
Mast sticking during extension or retraction.	Mast is dirty and/or requires lubrication.	<ol style="list-style-type: none"> 1) Clean and lubricate mast. 2) If condition continues, mast requires overhaul.
Mast leaks down when extended.	Air leak in mast or valve/compressor assembly.	Use a soapy water solution to pinpoint the leak. If the mast is leaking, it will require new seals. If the valve or compressor assembly is leaking at a fitting, remove the fitting, clean and reinstall using thread tape or sealant. Replace a faulty valve or compressor.

Symptom	Root Issue	Troubleshooting Sequence
Erratic or noisy when raising to 90°.	Bent or worn actuator or pivot shaft.	Replace damaged component.
RCP continually pans or tilts.	Bent flag in RCP.	<ol style="list-style-type: none"> 1) Remove RCP cover straighten or replace flag. 2) Make sure wiring is not wound tight. Reset home position.
Pan or tilt motor will not respond with no errors displayed on remote control(s).	Broken or loose motor wire lead or faulty motor.	<ol style="list-style-type: none"> 1) Reconnect wire lead. 2) Replace motor.
Mast fails to fully nest in saddle and disconnects power.	Binding of actuator, software fault or control erroneously sensed an increase in current.	<ol style="list-style-type: none"> 1) Check that Base Board has software version 2.6 or later. Contact Will-Burt if update is required. 2) See the Night Scan Product Troubleshooting Guide for software fault codes. 3) Check actuator for binding. Replace actuator if binding.
Mast will not begin to lower from 90° position.	Mast tube sections do not fully collapse.	<ol style="list-style-type: none"> 1) Extend and retract mast. 2) Check tube sections for damage. 3) Internal coil cord may be binding, contact Will-Burt.
Mast will not begin to lower from 90° position.	Magnetic switch band-clamped to mast is not made.	<ol style="list-style-type: none"> 1) Magnetic switch is may be out of adjustment. Loosen clamp and slide switch up and down the mast until contact is established. 2) Check wiring. 3) Replace defective magnetic switch.

(This page is intentionally left blank.)

Section 7 Appendix

This section contains the appendixes for your system.

7.1 Installing the PMRC

There are several types of controllers available for your system. This section will describe how to install the PMRC. See the drawings at the end of this manual for additional information on installing the controller including information on physical dimensions, and the placement of the mounting holes.

7.1.1 Attaching the PMRC

To attach the PMRC:

1. Find a convenient, dry location to mount the PMRC.
2. At the desired location, cut the panel to the dimensions of the PMRC (Figure 7-1).

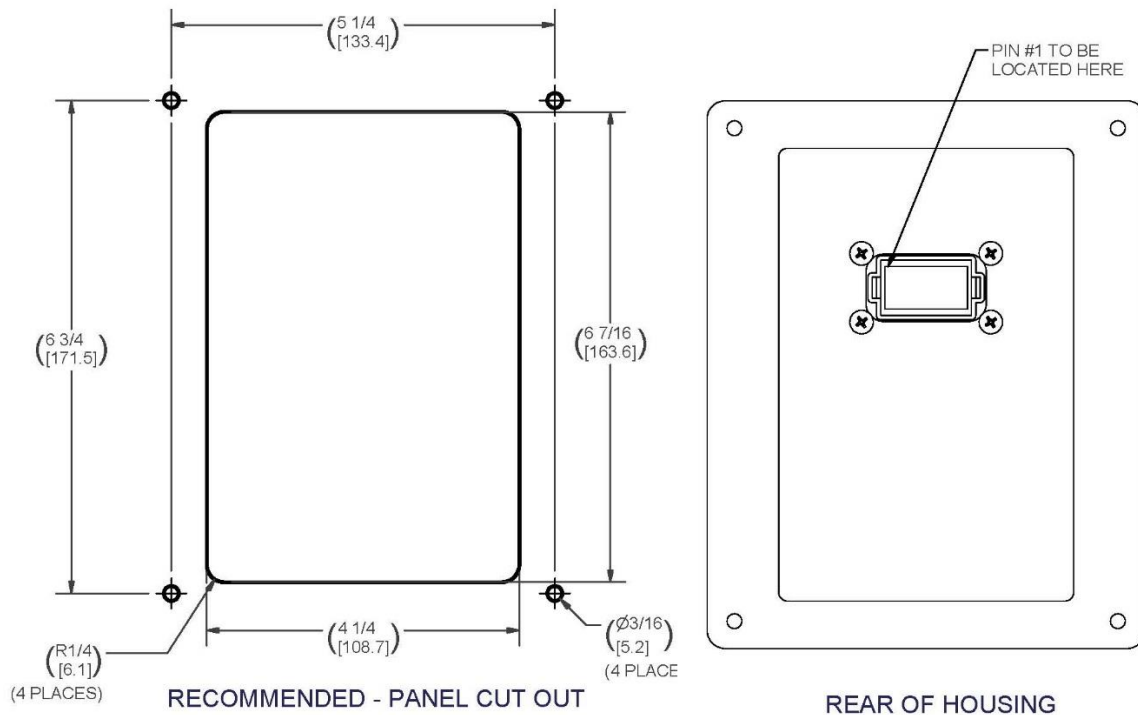

Figure 7-1 PMRC Dimensions

3. Provide four #10 round head screws.
4. Place the PMRC through the panel cutout.
5. From the front of the PMRC, fasten the PMRC to the base with the #10 screws.

7.1.2 Wiring the Base Board

See Section 2 of this manual for information on how to wire the Base Board.

7.1.3 Wiring the PMRC

One end of the Control Cable must be wired to a provided plug which connects to the back of the PMRC.

To wire the PMRC plug:

1. See the electrical drawings at the end of this manual.
2. Ensure power is disconnected from the system.
3. Connect the wires from the Control Cable to the supplied PMRC plug.
4. Plug the cable into the back of the PMRC.

7.2 Installing the Wireless HHRC

There are several types of controllers available for your system. This section will describe how to install the Dual-Tilt Wireless HHRC.

7.2.1 Attaching the J-Box

Wireless HHRCs require the installation of a junction box (also called a J-Box) with a “Start/Stop”  button. The J-Box should be placed in a dry location where the operator is most likely to be if it is needed to stop the system in an emergency. Hardware for attaching the J-Box is not included with the shipped items.

Attach the J-Box as follows:

1. Measure the thickness of the panel where the J-Box will mount.
2. Provide four #8 screws that are $\frac{3}{4}$ " plus the panel thickness long.
3. Provide four #8 lock washers and nuts.
4. Loosen the four J-Box cover screws and remove the J-Box cover.

5. Drill four holes through the mounting panel based on the mounting hole locations (Figure 7-2).

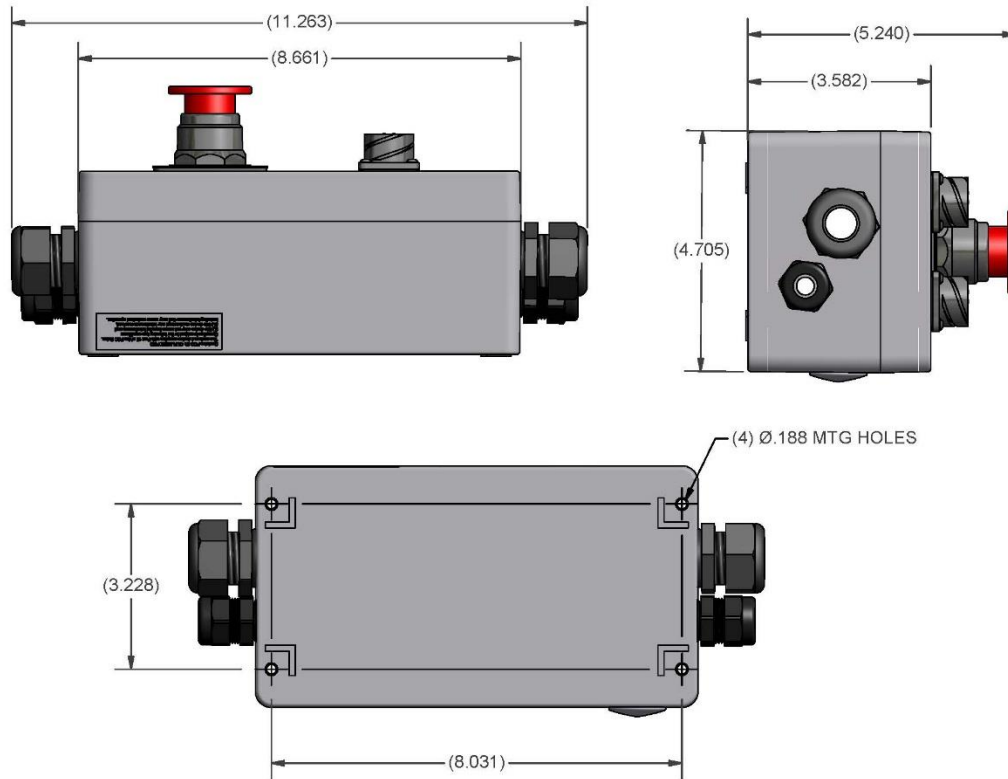

Figure 7-2 J-Box Dimensions

6. Place the J-Box on the panel.
7. Fasten the J-Box to the panel with the four #8 screws and with lock washers and nuts on the backside.

7.2.2 Attaching the Holder

See Section 2 of this manual for information on how to attaching the Holder for the HHRC.

7.2.3 Wiring the Base Board

See Section 2 of this manual for information on how to wire the Base Board.

7.2.4 Wiring the J-Box

To wire the J-Box:

1. See the electrical schematics in section 7.
2. Strip off ½" off the green, gray, and violet wires.

3. Connect the three wires to the terminal strip in the J-Box. Ensure that the wires match the J-Box label (GREEN, GRAY, VIOLET).
4. Replace the J-Box cover and tighten the four J-Box cover screws.

7.2.5 Connecting the Controller

The wireless HHRC can be operated in wired or wireless mode. To be used in wired mode, the HHRC must be plugged into J-Box. Before the wireless HHRC can be used in wireless mode, it must be initialized and charged.

To connect the Wireless HHRC:

1. Push the “Start/Stop”  button to ensure the system is off.
2. Plug the HHRC into the J-Box.
3. Twist the plug to the right to secure the connection.

7.2.5.1 Initializing the Wireless HHRC and J-Box

The wireless HHRC must be plugged into the J-Box when the unit is first powered up so that the HHRC wireless module can be initialized. During initialization, the wireless module in the HHRC and the wireless module in the J-Box negotiate to configure the devices to only communicate with each other. Once complete, the wireless HHRC may be disconnected and will operate the unit in wireless mode so long as the J-Box has power. If the J-Box is turned off or cycled, the wireless HHRC will need reinitialized.

7.2.5.2 Charging the Wireless HHRC

During operation, the display will show the charge level by indicating “BAT xx%” when not in sleep mode. When the unit is not in use, the wireless HHRC should be plugged into the J-Box to charge. The word “Charging” will flash on the wireless HHRC display during this process. The first time the wireless HHRC is charged will take 24 hours. With normal use, it will subsequently charge in approximately 15 to 20 minutes. If left unplugged, it will eventually self-discharge and may take 20-24 hours to get back to 100%. In order to conserve power, the wireless HHRC enters sleep mode within 5 seconds if no buttons are pressed.

Section 8 Drawings

This section contains drawings for your system.

(This page is intentionally left blank.)

TABLE 1 - CONTROLLER WIRING

APPLICATION	MODEL	DRAWING
HHRC or PANEL MOUNT w/E-STOP	BOTH	WD-72312
WIRELESS J-BOX	POWERLITE	WD-72307
WIRELESS HHRC WITH E-STOP BOX	CHIEF	WD-72007

REVISIONS

ECN	REV	DESCRIPTION	DATE	BY/APPL
12247	J	ADD WIRING DETAILS FOR 12V COMPRESSOR	06-19-14	DJB/AW
12339	K	ADD NOTE FOR NEW CABLE	08-20-14	DJB/AW
12580	L	ADD CHIEF WIRING DETAILS FROM DWG 46066	03/02/15	DJB/AW
12746	M	ADD DTEC II WIRING DETAILS FOR INFLEXION PLUS	05-28-15	DJB/AW
12827	N	CHANGE CAMERA POWER WIRING, WAS 87 TO 86	07-28-15	DJB/AW

NOTES:
1. INSTALLER WIRING

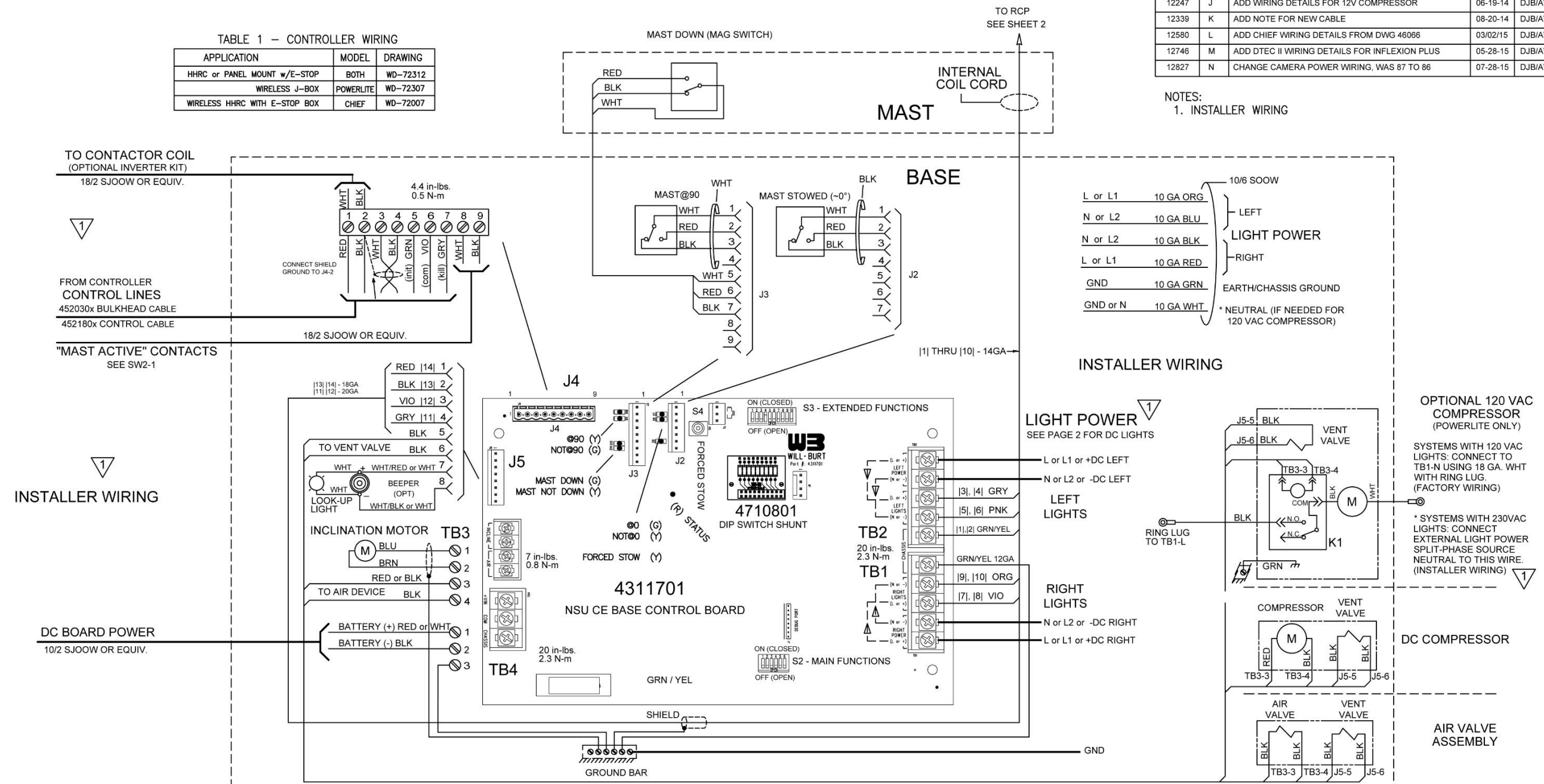

INSTALLER WIRING

WIRE	GAUGE	FUNCTION
L or L1	10 GA ORG	LEFT LIGHT POWER
N or L2	10 GA BLU	
N or L2	10 GA BLK	RIGHT LIGHT POWER
L or L1	10 GA RED	
GND	10 GA GRN	EARTH/CHASSIS GROUND
GND or N	10 GA WHT	* NEUTRAL (IF NEEDED FOR 120 VAC COMPRESSOR)

INSTALLER WIRING

AWG	in-lbs.
14-10 CU	20
12-10 AL	20
(2)14, 12 CU	25
(2)12, 10 AL	25
8	25
6 - 4	35

BASE DIP SWITCH S2: MAIN FUNCTIONS

POS	OFF (OPEN)	ON (CLOSED)
1	J4 8,9 OPEN WHEN ACTIVE	J4 8,9 CLOSED WHEN ACTIVE
2	NFPA MODE	STANDARD
3	RCP	NO RCP
4	ROOF MOUNT	VERTICAL
5	UNUSED	UNUSED
6	NORMAL	DO NOT USE

BASE DIP SWITCH S3: EXTENDED FUNCTIONS* OR SET CHIEF WIRELESS ADDRESS

POS	OFF (OPEN)	ON (CLOSED)
1	NO D-TEC	D-TEC PRESENT
2	NO WELL COVER	WELL COVER
4*	-	ENABLE EXTENDED FUNCTIONS
8	-	+5 SEC. UP TO RCP ACTIVE
9	-	+10 SEC. UP TO RCP ACTIVE
3, 5-7, 10	- NOT USED	

MATERIAL NS Universal DWG	UNLESS OTHERWISE SPECIFIED DIMENSIONS ARE IN INCHES TOLERANCES ON: DECIMALS ANGLES 0 ± .015 0.00 ± .005 FRACTIONS ± BREAK ALL SHARP CORNERS ✓ ON ALL MACHINED SURFACES	THIS DOCUMENT CONTAINS PROPRIETARY INFORMATION AND SHALL NOT BE USED OR REPRODUCED OR ITS CONTENTS DISCLOSED IN WHOLE OR IN PART WITHOUT THE PRIOR WRITTEN CONSENT OF THE WILL-BURT COMPANY. FOR LOGISTICAL SUPPORT ONLY	AN EMPLOYEE OWNED COMPANY ORRVILLE, OHIO NightScan Products, roof-mount WITH 4311701 UNIVERSAL CONTROL BASE WIRING
FINISH			SIZE B DWG. No. WD-46276 SCALE NTS SHEET 1 OF 2

Night Scan Products, roof-mount
with 4311701 Universal Control
Base Wiring

Drawing: WD-46276

Sheet 1 of 2

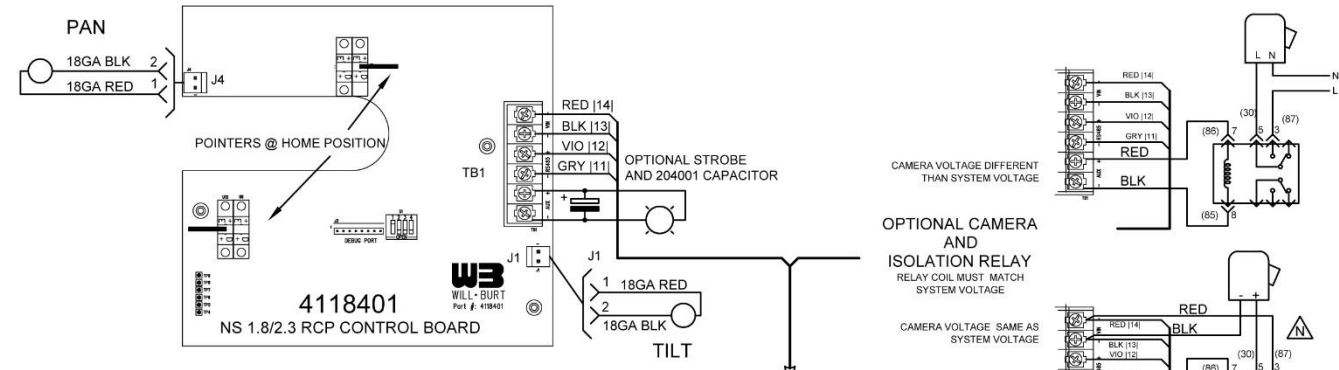

RCP DIP SWITCH S1

POS	OPEN (OFF)	CLOSED (ON)
1	STOP ON FAULT	STOW ON FAULT
2	NOT PROFILER	PROFILER
3	STOW WHILE LOWERING	STOW BEFORE LOWERING
4	DEFAULT	FACTORY ONLY

**SINGLE-TILT RCP
DUAL-TILT RCP**

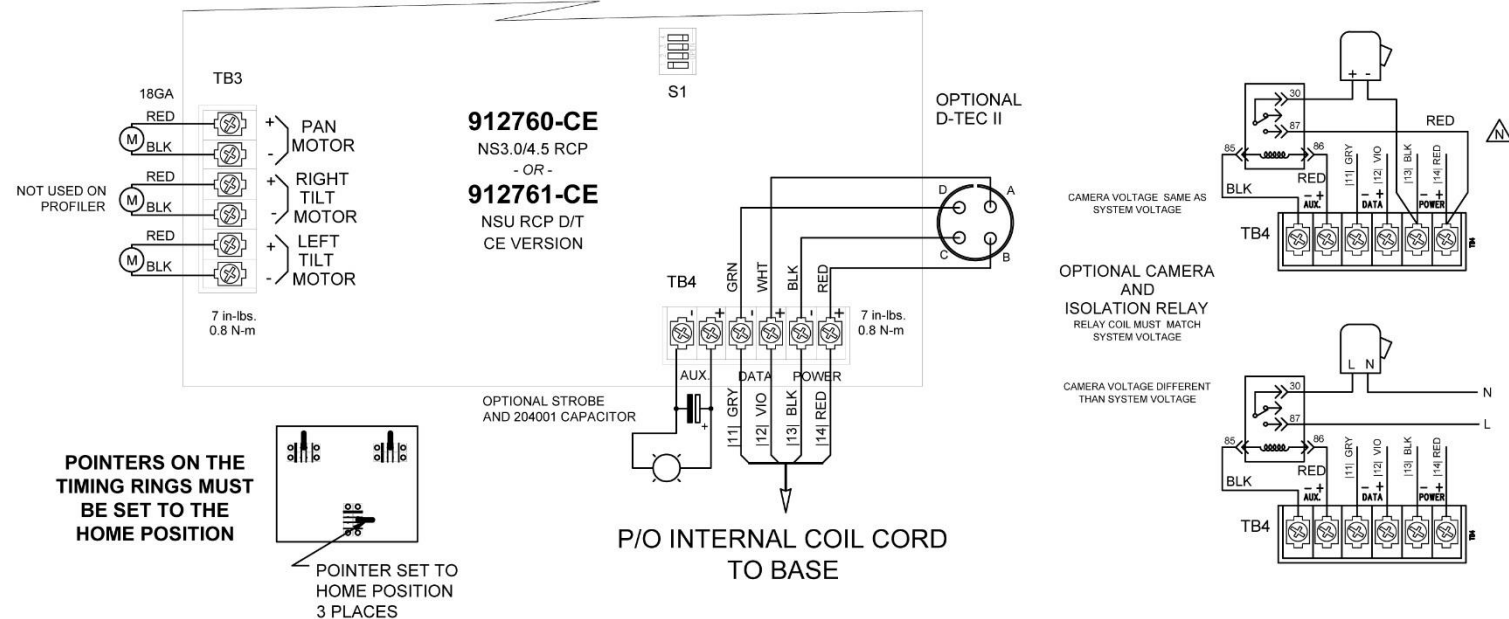

POINTERS ON THE TIMING RINGS MUST BE SET TO THE HOME POSITION

POINTER SET TO HOME POSITION 3 PLACES

INFLEXION Plus

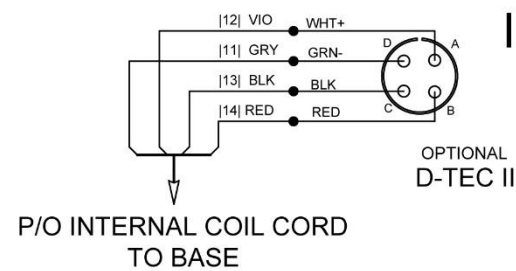

REVISIONS				
ECN	REV	DESCRIPTION	DATE	BY/APPL
12247	J	ADD WIRING DETAILS FOR 12V COMPRESSOR	06-19-14	DJB/AW
12339	K	ADD NOTE FOR NEW CABLE	08-20-14	DJB/AW
12580	L	ADD CHIEF WIRING DETAILS FROM DWG 46066	03/02/15	DJB/AW
12746	M	ADD DTEC II WIRING DETAILS FOR INFLEXION PLUS	05-28-15	DJB/AW
12827	N	CHANGE CAMERA POWER WIRING, WAS 87 TO 86	07-28-15	DJB/AW

LIGHT POWER WIRING

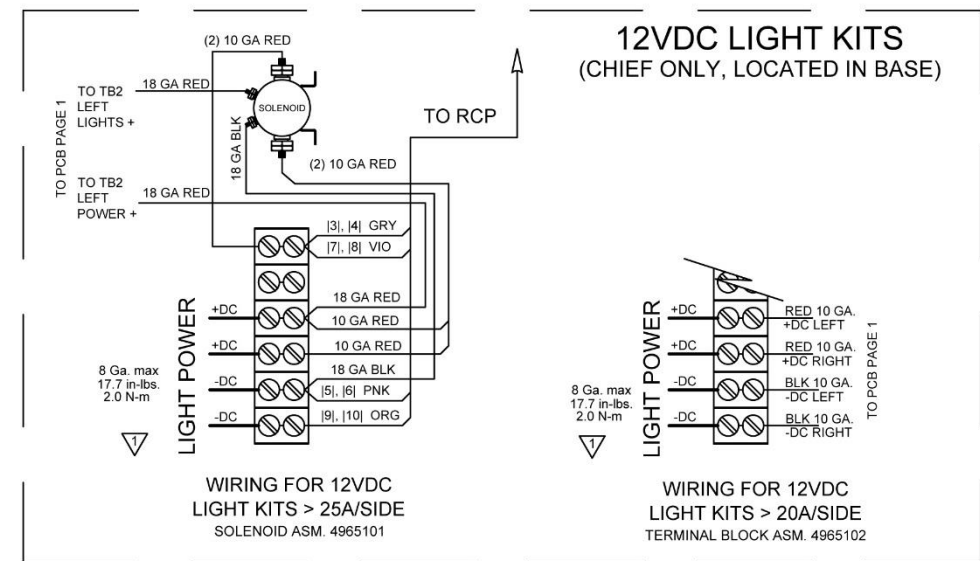
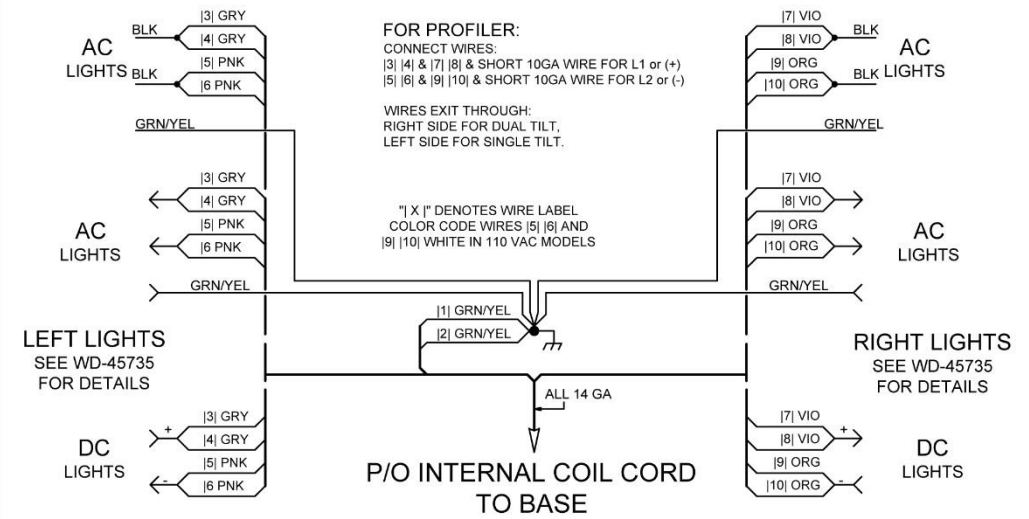

MATERIAL NS Universal DWG	UNLESS OTHERWISE SPECIFIED DIMENSIONS ARE IN INCHES	THIS DOCUMENT CONTAINS PROPRIETARY INFORMATION AND SHALL NOT BE USED OR REPRODUCED OR ITS CONTENTS DISCLOSED IN WHOLE OR IN PART WITHOUT THE PRIOR WRITTEN CONSENT OF THE WILL-BURT COMPANY. FOR LOGISTICAL SUPPORT ONLY	AN EMPLOYEE OWNED COMPANY ORRVILLE, OHIO NightScan Products, roof-mount WITH 4311701 UNIVERSAL CONTROL RCP WIRING
FINISH	TOLERANCES ON: DECIMALS ±.12" FRACTIONS ±. BREAK ALL SHARP CORNERS ✓ ON ALL MACHINED SURFACES		

Night Scan Products, roof-mount
with 4311701 Universal Control
Base Wiring

Drawing: WD-46276

Sheet 2 of 2

POWERLITE WIRELESS, J-BOX ONLY

REVISIONS				
ECN	REV	DESCRIPTION	DATE	BY/APPVL
12580	00	NEW	03-02-15	DJB/

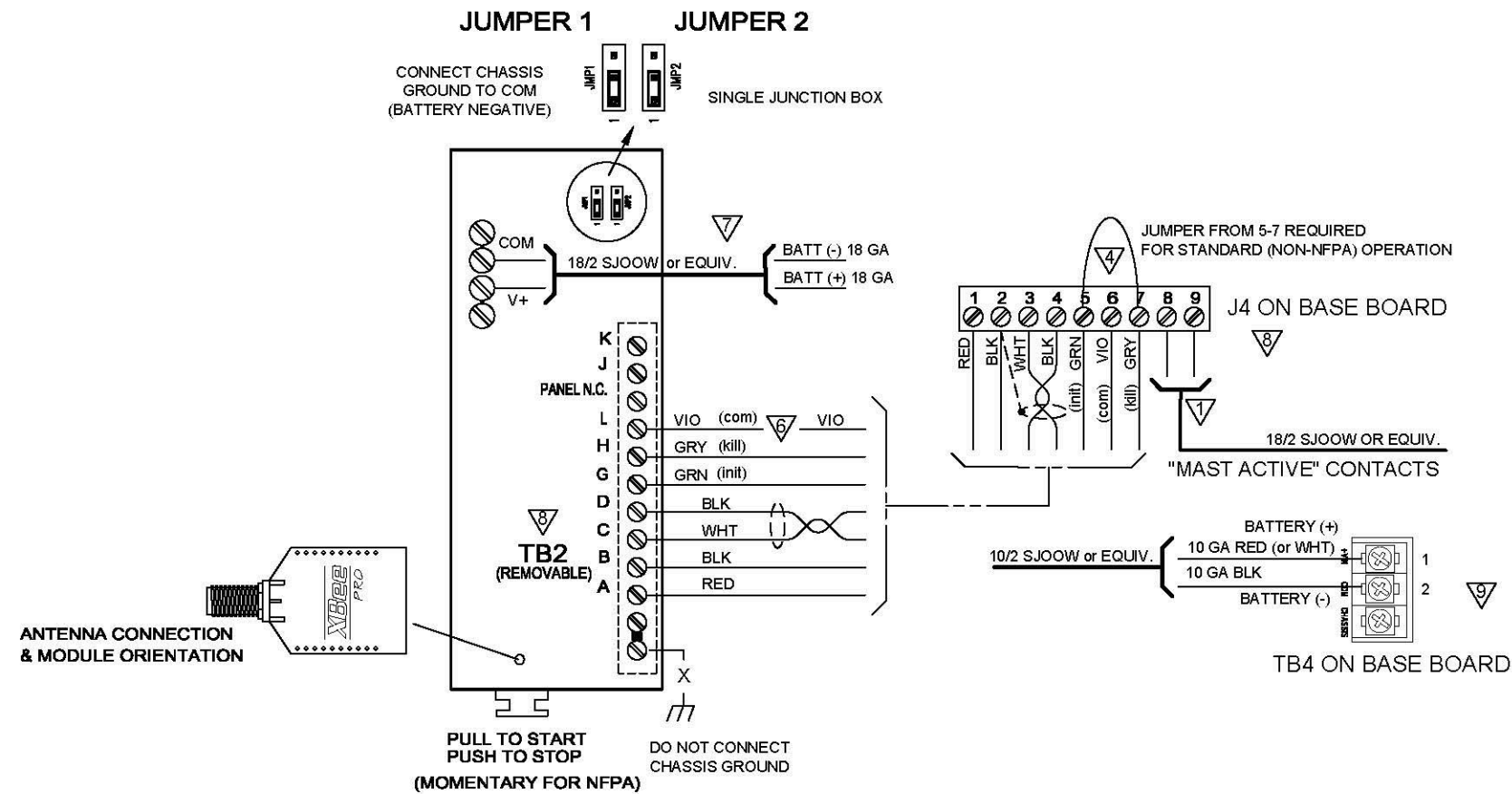

NOTES

- "MAST ACTIVE" CONTACTS, J4 8,9:
USE SW2-1 ON BASE BOARD TO SELECT OPEN OR CLOSED WHEN MAST ACTIVE.
SW2-1 OPEN = CONTACTS OPEN WHEN ACTIVE.
SW2-1 CLOSED = CONTACTS CLOSED WHEN ACTIVE.
- 2 AMPS MAX CURRENT, 20 GA. MINIMUM CONDUCTOR. 18/2 SJOOW AVAILABLE.
- SW2-2 ON BASE BOARD MUST BE OPEN (OFF) FOR NFPA MODE.
- SW2-2 ON BASE BOARD MUST BE CLOSED (ON) STANDARD MODE.
- REMOVE JUMPER(S) IF REPLACED BY PARKING BRAKE INTERLOCK. J4-5 TO J4-7 CLOSED WHEN BRAKE "ON". THIS FUNCTION AVAILABLE IN STANDARD MODE ONLY.
- 452180x CABLE: ALL WIRES 20 GA. EXCEPT RED AND BLACK (J4-1 AND 2).
- OPTIONAL DISABLE INPUT, CUSTOMER SUPPLIED CONTACTS. MUST HAVE CONTINUITY TO FUNCTION. WILL NOT ALLOW OPERATION IF OPEN, ACTS AS EMERGENCY STOP
- 18 GA. MIN. FOR BOARD POWER. SEPARATE 10 GA TO BASE BOARD REQUIRED.
- TORQUE: 4.4in-lbs, 0.5Nm
- TORQUE: 20in-lbs, 2.3Nm

AutoCAD Drawing: NSU J-Box Wiring3.dwg	UNLESS OTHERWISE SPECIFIED DIMENSIONS ARE IN INCHES TOLERANCES ON: DECIMALS ANGLES 0 = ± 1/2" 00 = ± 000 = ± FRACTIONS = BREAK ALL SHARP CORNERS 125° ON ALL MACHINED SURFACES	THIS DOCUMENT CONTAINS PROPRIETARY INFORMATION AND SHALL NOT BE USED OR REPRODUCED OR ITS CONTENTS DISCLOSED IN WHOLE OR IN PART, WITHOUT THE PRIOR WRITTEN CONSENT OF THE WILL-BURT COMPANY. FOR LOGISTICAL SUPPORT ONLY SIGNATURE DATE DR BY DJB - CK BY JDN - APP BY	<p>WB AN EMPLOYEE OWNED COMPANY ORRVILLE, OHIO</p> <p>nightscan™ POWERLITE ROOF-MOUNT, NFPA or STANDARD, WIRELESS J-BOX</p> <p>SIZE DWG. No. WD-72307 A</p> <p>SCALE NTS SHEET 1 OF 1</p>
---	---	---	--

Night Scan Powerlite
Roof-Mount, NFPA or Standard
Wireless J-Box

Drawing: WD-72307

Sheet 1 of 1

REMOTES WITH EMERGENCY STOP

REVISIONS				
ECN	REV	DESCRIPTION	DATE	BY/APPVL
12580	00	NEW, REPLACES WD-72212 FOR CURRENT PRODUCTION	03-02-15	DJB/

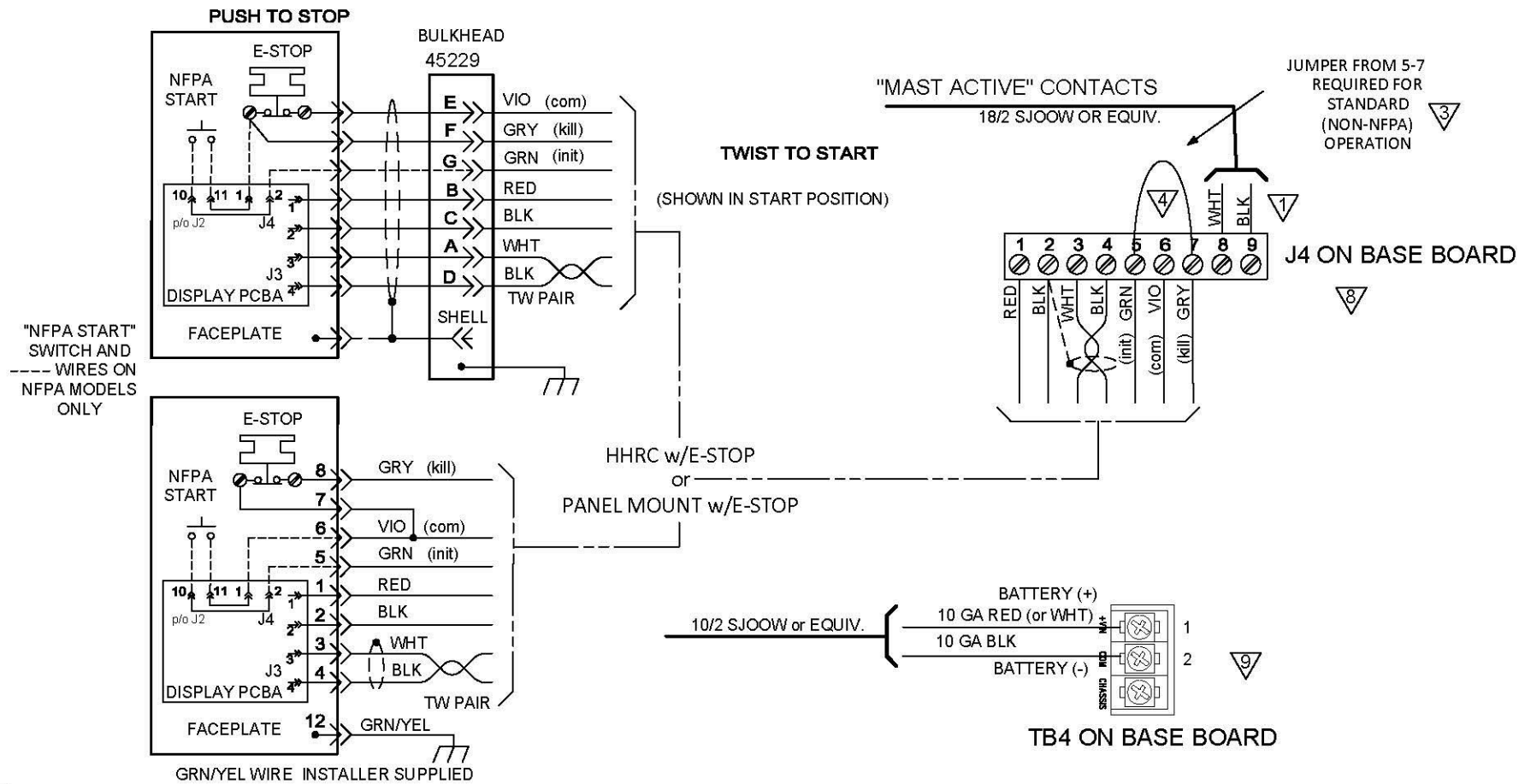

NOTES

- "MAST ACTIVE" CONTACTS, J4 8,9:
USE SW2-1 ON BASE BOARD TO SELECT OPEN OR CLOSED WHEN MAST ACTIVE.
SW2-1 OPEN = CONTACTS OPEN WHEN ACTIVE.
SW2-1 CLOSED = CONTACTS CLOSED WHEN ACTIVE.
2 AMPS MAX CURRENT, 20 GA. MINIMUM CONDUCTOR. 18/2 SJOOW AVAILABLE.
- SW2-2 ON BASE BOARD MUST BE OPEN (OFF) FOR NFPA MODE.
- SW2-2 ON BASE BOARD MUST BE CLOSED (ON) STANDARD MODE.
- REMOVE JUMPER(S) IF REPLACED BY PARKING BRAKE INTERLOCK. J4-5 TO J4-7 CLOSED WHEN BRAKE "ON". THIS FUNCTION AVAILABLE IN STANDARD MODE ONLY.
- 452180x CABLE: ALL WIRES 20 GA. EXCEPT RED AND BLACK (J4-1 AND 2).
- OPTIONAL DISABLE INPUT, CUSTOMER SUPPLIED CONTACTS. MUST HAVE CONTINUITY TO FUNCTION. WILL NOT ALLOW OPERATION IF OPEN, ACTS AS EMERGENCY STOP
- 18 GA. MIN. FOR BOARD POWER. SEPARATE 10 GA TO BASE BOARD REQUIRED.
- TORQUE: 4.4in-lbs, 0.5Nm
- TORQUE: 20in-lbs, 2.3Nm

AutoCAD Drawing: NSU J-Box Wiring3.dwg	UNLESS OTHERWISE SPECIFIED DIMENSIONS ARE IN INCHES TOLERANCES ON: DECIMALS 0" ± .12" 99" ± .005" FRACTIONS ± BREAK ALL SHARP CORNERS 125° ON ALL MACHINED SURFACES	THIS DOCUMENT CONTAINS PROPRIETARY INFORMATION AND SHALL NOT BE USED OR REPRODUCED OR ITS CONTENTS DISCLOSED IN WHOLE OR IN PART, WITHOUT THE PRIOR WRITTEN CONSENT OF THE WILL-BURT COMPANY. FOR LOGISTICAL SUPPORT ONLY SIGNATURE DATE DR BY DJB - CK BY JDN - APP BY	<p>W3 AN EMPLOYEE OWNED COMPANY ORRVILLE, OHIO WILL BURT</p> <p>nightscan™ UNIVERSAL CONTROL ROOF-MOUNT, NFPA or STANDARD, CONTROLLER with E-STOP</p> <p>SIZE DWG. No. WD-72312</p> <p>SCALE NTS SHEET 1 OF 2</p>
---	---	---	---

Night Scan Universal Control
Roof-Mount, NFPA or Standard,
Controller with E-Stop

Drawing: WD-72312

Sheet 1 of 2

(2) REMOTES WITH EMERGENCY STOP

REVISIONS				
ECN	REV	DESCRIPTION	DATE	BY/APPVL
12580	00	NEW, REPLACES WD-72212 FOR CURRENT PRODUCTION	03-02-15	DJB/

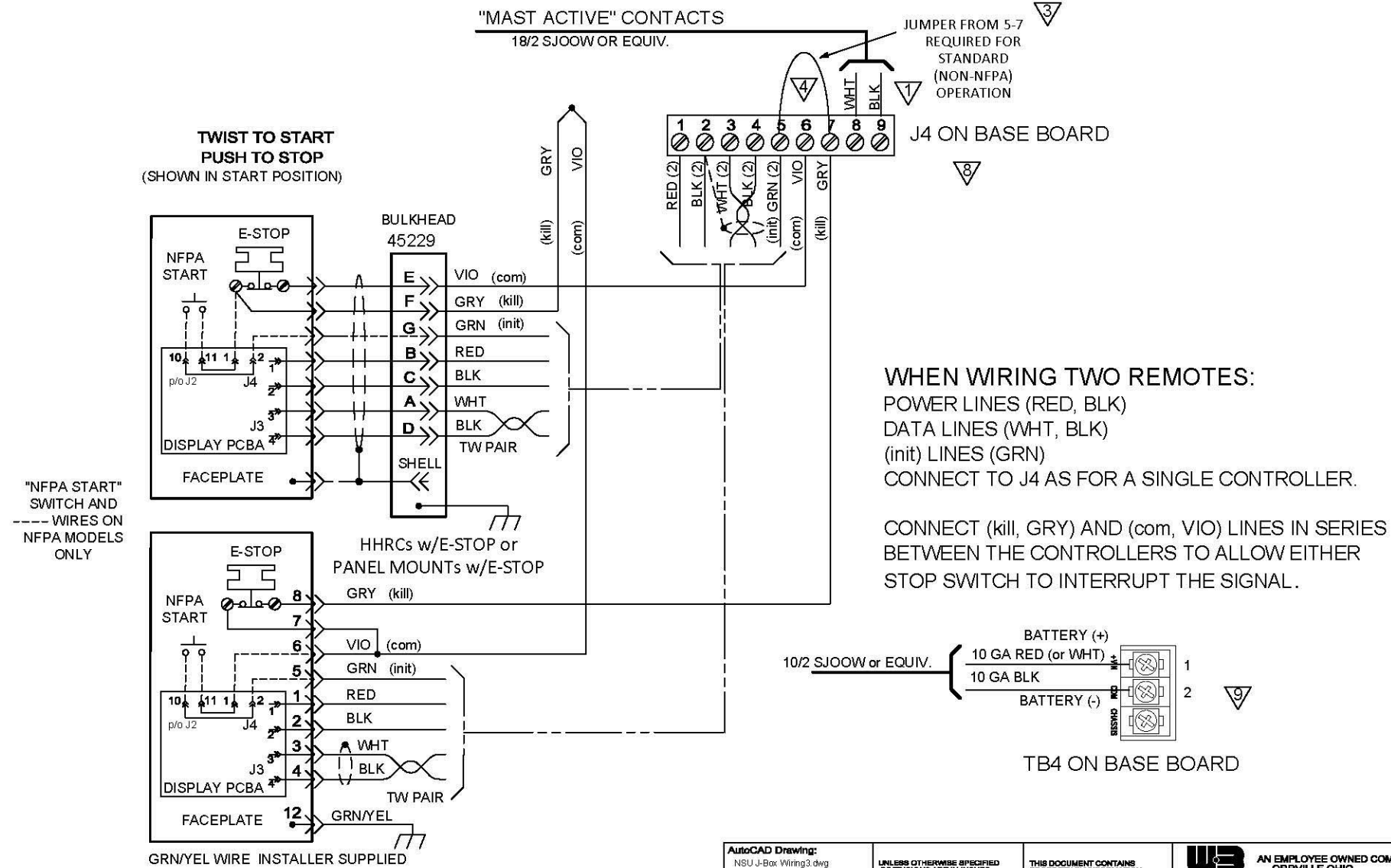

AutoCAD Drawing: NSU J-Box Wiring3.dwg	UNLESS OTHERWISE SPECIFIED DIMENSIONS ARE IN INCHES	THIS DOCUMENT CONTAINS PROPRIETARY INFORMATION AND SHALL NOT BE USED OR REPRODUCED OR ITS CONTENTS DISCLOSED IN WHOLE OR IN PART, WITHOUT THE PRIOR WRITTEN CONSENT OF THE WILL-BURT COMPANY.	W3 WILL BURT AN EMPLOYEE OWNED COMPANY ORRVILLE, OHIO
FINISH	TOLERANCES ON: DECIMALS ANGLES ± .005 ± .12° FRACTIONS ± BREAK ALL SHARP CORNERS ✓ ON ALL MACHINED SURFACES	FOR LOGISTICAL SUPPORT ONLY	nightscan™ UNIVERSAL CONTROL ROOF-MOUNT, NFPA or STANDARD, CONTROLLER with E-STOP
		SIGNATURE DATE	SIZE DWG. No. WD-72312
		DR. BY: DJB - CK. BY: JDN - APP. BY:	SCALE NTS SHEET 2 OF 2

Night Scan Universal Control
Roof-Mount, NFPA or Standard,
Controller with E-Stop

Drawing: WD-72312

Sheet 1 of 2