



EXPEDITION™ SERIES

RANGER™ MAST OPERATOR'S MANUAL



The Will-Burt Company
401 Collins Blvd
Orrville, OH 44667, U.S.A.

Phone: +1 330 684 4000
E-Mail: info@willburt.com
Website: www.willburt.com

TP-4549901-G, February 2024
© 2024 The Will-Burt Company
Original Instructions

Authorized Representative:
Will-Burt Germany GmbH & Co. KG
Fischergasse 25
D-91344 Waischenfeld, Germany

INNOVATION ELEVATED®

Expedition Series™ Ranger™ Mast Warranty

Will-Burt warrants its Expedition Series™ Ranger™ Masts to be free from defects in material and workmanship for a period of two (2) years, with such time period running from the date of shipment by Will-Burt. Will-Burt shall not be responsible for any damage resulting to or caused by its products by reason of failure to properly install, maintain or store the product; use of the product in a manner inconsistent with its design; unauthorized service, alteration of products, neglect, abuse, accident, or acts of God. This warranty does not extend to any component parts not manufactured by Will-Burt; provided, however, Will-Burt's warranty herein shall not limit any warranties by manufacturers of component parts which extend to the buyer.

THE FOREGOING WARRANTY IS IN LIEU OF ALL OTHER WARRANTIES, AND NO REPRESENTATIONS, GUARANTEES OR WARRANTIES, EXPRESS OR IMPLIED, INCLUDING BUT NOT LIMITED TO, A WARRANTY OF MERCHANTABILITY, FITNESS FOR A PARTICULAR PURPOSE, OR NON-INFRINGEMENT ARE MADE BY WILL-BURT IN CONNECTION WITH THE MANUFACTURE OR SALE OF ITS PRODUCTS. NO EMPLOYEE, DISTRIBUTOR, OR REPRESENTATIVE IS AUTHORIZED TO CHANGE THIS WARRANTY IN ANY WAY OR GRANT ANY OTHER WARRANTY ON BEHALF OF WILL-BURT.

Claims for defects in material and workmanship shall be made in writing to Will-Burt within thirty (30) days of the discovery of defect. Failure to provide notice as required hereby shall be conclusive evidence that the product was in conformity with the warranty, and Will-Burt shall be released from any and all liability relating to the product. Will-Burt may either send a service representative or have the product returned to its factory at Buyer's expense for inspection. If judged by Will-Burt to be defective in material or workmanship, the product will be replaced or repaired at the option of Will-Burt, free from all charges except authorized transportation.

THE REMEDIES OF BUYER SET FORTH HEREIN ARE EXCLUSIVE AND ARE IN LIEU OF ALL OTHER REMEDIES. THE LIABILITY OF WILL-BURT WHETHER IN CONTRACT, TORT, UNDER ANY WARRANTY, OR OTHERWISE, SHALL NOT EXTEND BEYOND ITS OBLIGATION TO REPAIR OR REPLACE, AT ITS OPTION, ANY PRODUCT OR PART FOUND BY WILL-BURT TO BE DEFECTIVE IN MATERIAL OR WORKMANSHIP. WILL-BURT SHALL NOT BE LIABLE FOR COST OF INSTALLATION AND/OR REMOVAL, OR BE RESPONSIBLE FOR DIRECT, INDIRECT, SPECIAL OR CONSEQUENTIAL DAMAGES OF ANY NATURE.

Document History

Document	Dates	Remarks
TP-4549901-00	10/4/2010	Initial Release
TP-4549901-A	2/15/11	Added reference to replacement kits (Section 4.2)
TP-4549901-B	4/6/2011	Change to a caution and to step 39.
TP-4549901-C	4/26/2011	Added Staging Guy Lines.
TP-4549901-D	5/8/2012	Added cable weight note and height to stage guy lines.
TP-4549901-E	12/3/2013	Updated warranty page.
TP-4549901-F	2/2/2017	Formatting updates.
TP-4549901-G	2/29/2024	Updated to WB format. Consolidated EZ RAZE info into this manual.

Table of Contents

Section 1 Safety Summary	vii
1.1 Signal Word Definitions	vii
1.2 Safety Instructions	vii
1.3 Symbols	xiv
Section 2 Introduction	2-1
2.1 Intended Use	2-2
2.2 Definitions	2-2
2.3 Mast Component Descriptions	2-3
Section 3 Technical Data	3-1
3.1 Payload Capacity and Wind Effects	3-1
Section 4 Installation	4-1
4.1 Pre-Installation Check	4-1
4.2 Select a Suitable Mounting Location	4-1
4.3 Recommended Installation Tools	4-2
4.4 Unpack the Mast System	4-2
4.5 Set Up the Tripod	4-4
4.6 Deploy the Mast	4-6
4.6.1 Manual Deployment	4-7
4.6.1.1 Install the Top of the Mast	4-7
4.6.1.2 Complete Tripod Installation	4-12
4.6.1.3 Raise the Mast	4-13
4.6.2 Deployment with EZ Raze™ Option	4-18
4.6.2.1 Install the Top of the Mast	4-18
4.6.2.2 Complete Tripod Installation	4-24
4.6.2.3 Raise the Mast	4-26
4.6.2.4 Raise the Payload	4-31
Section 5 Disassembly	5-1
5.1 Disassemble the Mast	5-1
5.2 Disassemble the Mast with EZ Raze™ Option	5-2
Section 6 Transportation	6-1
6.1 General Transportation	6-1
6.2 Shipping	6-1
Section 7 Maintenance	7-1
7.1 Pre-Maintenance Check	7-1
7.2 Maintenance Equipment	7-1
7.3 Spare Parts	7-2
7.4 Periodic Maintenance	7-2
7.5 Checking and Adjusting Clamp Tightness	7-3
7.6 Long-Term Storage	7-4
7.7 System Disposal	7-4

Table of Figures

Figure 2-1 Telescoping Mast Parts (Not to Scale)	2-5
Figure 2-2 Tripod, Base Plate Assembly and Tripod Step.....	2-5
Figure 2-3 Some Guy Bag Components (Not to Scale).....	2-6
Figure 2-4 Guy Collars	2-6
Figure 2-5 EZ Raze™ Option Non-Deployed	2-7
Figure 2-6 EZ Raze™ Option Disassembled.....	2-7
Figure 2-7 Some EZ Raze™ Option Components	2-8
Figure 2-8 Accessories (Bolster Plate, NATO Plate and Cup Holder Shown).....	2-8
Figure 4-1 Unzip the wheeled bag and remove the tripod and base tube.	4-2
Figure 4-2 Open the guy bag	4-3
Figure 4-3 Open the short bag	4-3
Figure 4-4 Open the tube bag	4-3
Figure 4-5 Unlocking	4-4
Figure 4-6 Locking	4-4
Figure 4-7 Insert Hitch Pin	4-4
Figure 4-8 Secure Hitch Pin	4-4
Figure 4-9 Stand Up Tripod.....	4-5
Figure 4-10 Unlock.....	4-5
Figure 4-11 Open the Tripod.....	4-5
Figure 4-12 Partially Raise the Tripod Legs.....	4-6
Figure 4-13 Lock the Upper Clamp and Unlock the Lower Clamp	4-7
Figure 4-14 Insert Top Tube from the Top of the Tripod	4-7
Figure 4-15 Lower Top Tube Until There is One Hand Width from the Bottom of the Tube and Lock the Lower Clamp	4-8
Figure 4-16 Unlock the 4-Way Guy Collar and Place the Guy Collar onto the Top Tube	4-8
Figure 4-17 Lock the Guy Collar Clamps.....	4-9
Figure 4-18 Slide Arm Collar onto Top Tube	4-9
Figure 4-19 Lock Top and Bottom Clamps	4-9
Figure 4-20 Pin Arm in Place	4-10
Figure 4-21 Pin Payload Adaptor in Place	4-10
Figure 4-22 Place Guy Collar onto Top Tube	4-11
Figure 4-23 Connect Hook Ends to 4-Way Guy Collar	4-11
Figure 4-24 Raise Tripod Legs.....	4-12
Figure 4-25 Adjust Legs as Needed and Consult Bubble Level to Ensure Tripod is Level	4-12
Figure 4-26 Stake the Tripod	4-13
Figure 4-27 Installation Progress	4-13
Figure 4-28 Attach Base Plate to Base Tube.....	4-14
Figure 4-29 Drive the Stakes a Distance Equal to the Mast Height from the Center of the Mast	4-14
Figure 4-30 Drive Each Stake into the Ground at a 45° Angle	4-15
Figure 4-31 Prepare Guy Lines.....	4-15
Figure 4-32 Place a Tube into the Bottom	4-16
Figure 4-33 Push Up	4-16
Figure 4-34 Button in Notch	4-16

Figure 4-35 Lower to Ground 4-16

Figure 4-36 Stake the Base Plate 4-17

Figure 4-37 Tighten Guy Lines..... 4-17

Figure 4-38 Lock the Upper Clamp and Unlock the Lower Clamp 4-18

Figure 4-39 Insert Top Tube from the Top of the Tripod 4-18

Figure 4-40 Lower Top Tube until There is One Hand Width from the Bottom of the Tube and Lock the Lower Clamp 4-19

Figure 4-41 Slide Carriage Assembly onto the Top Tube..... 4-19

Figure 4-42 Tip Tube..... 4-20

Figure 4-43 Insert Tip Tube..... 4-20

Figure 4-44 Ensure the Eyelet is on the Backside of the Mast 4-20

Figure 4-45 Ensure the Platform Stub Goes Between the Edges of the Carriage 4-20

Figure 4-46 Side Bracket 4-21

Figure 4-47 Back View 4-21

Figure 4-48 Insert Long Pins..... 4-21

Figure 4-49 Pick an Angle for the Extension Arm and Pin into Place..... 4-21

Figure 4-50 Arm Not Extended 4-21

Figure 4-51 If Required, Extend and Pin..... 4-21

Figure 4-52 Cup Holder..... 4-22

Figure 4-53 Connect the Bolster Plate to the Carriage 4-22

Figure 4-54 Connect Cable to the Carriage 4-23

Figure 4-55 Feed Through Pulley 4-23

Figure 4-56 Connect to Eyelet 4-23

Figure 4-57 Guy Lines..... 4-24

Figure 4-58 Hook to Guy Plate 4-24

Figure 4-59 Single Line to Collar 4-24

Figure 4-60 Raise Tripod Legs..... 4-24

Figure 4-61 Adjust Legs as Needed and Consult Bubble Level to Ensure Tripod is Level 4-25

Figure 4-62 Stake the Tripod 4-25

Figure 4-63 Attach Base Plate to Winch Tube..... 4-26

Figure 4-64 Drive the Stakes a Distance Equal to the Mast Height from the Center of the Mast 4-26

Figure 4-65 Drive Each Stake into the Ground at a 45° Angle 4-27

Figure 4-66 Unlock Winch Spool 4-27

Figure 4-67 Use the Hitch Pin to Attach the Handle to the Winch 4-27

Figure 4-68 Prepare Guy Lines..... 4-28

Figure 4-69 Cable Path Shown in Red 4-28

Figure 4-70 Add Slack to Cable 4-28

Figure 4-71 Line Up 4-29

Figure 4-72 Push Tube Up..... 4-29

Figure 4-73 Button in Notch 4-29

Figure 4-74 Push Tube Up..... 4-29

Figure 4-75 Lock Lower Clamp 4-29

Figure 4-76 Lock J-hook 4-30

Figure 4-77 J-hook Locked 4-30

Figure 4-78 Stake the Base Plate 4-30

Figure 4-79 Tighten Guy Lines.....	4-31
Figure 4-80 Use the Hitch Pin to Attach the Step to the Tripod.....	4-31
Figure 4-81 Unlock Winch Spool	4-32
Figure 4-82 Turn the Winch Handle Counterclockwise to Raise the Payload	4-32
Figure 7-1 Periodic Inspections.....	7-2
Figure 7-2 Lock the Clamp.....	7-3
Figure 7-3 No Gaps Between the Clamp Housing and Nut.....	7-3
Figure 7-4 Turn the Nut by Hand in the “+” Direction Shown on the Nut to Ensure the Clamp is Tight	7-4

Table of Tables

Table 2-1 Mast Components.....	2-3
Table 2-2 Mast Components with EZ Raze™ Option	2-4
Table 3-1 Ranger™ Mast Specifications	3-2
Table 4-1 Tools and Materials Required for Installation	4-2
Table 7-1 Equipment Recommended for Maintenance	7-1

Section 1 Safety Summary

This section describes safety instructions for the Ranger™ Mast that personnel must understand and apply throughout all product activities such as transportation, handling, installation, deployment, disassembly, maintenance, storage, disposal and troubleshooting. Read and understand this entire document, and contact The Will-Burt Company with any questions, before performing any procedure outlined in this document. Keep this document during the entire duration of use of the device. Pass this document along to trained and qualified end users.

1.1 Signal Word Definitions

The following signal words and definitions are used to indicate hazardous situations:

DANGER

DANGER indicates an imminently hazardous situation that, if not avoided, will result in death or serious injury.

WARNING

WARNING indicates a potentially hazardous situation that, if not avoided, could result in death or serious injury.

CAUTION

CAUTION indicates a potentially hazardous situation that, if not avoided, may result in minor or moderate injury. It is also used to alert against unsafe practices.

1.2 Safety Instructions

DANGER

Electrocution Hazard! Contact with high voltage will result in death or serious injury. Observe general safety precautions for handling equipment using high voltage. Do not locate or operate mast near electrical lines, cables or other unwanted sources of electricity. Allow sufficient clearance on all sides of mast to allow for side sway. Do not operate mast during an electrical storm. Be certain electrical cables are undamaged and properly terminated. Do not touch live wires. Follow OSHA or other national safety regulations when working near energized power lines. Personnel working with or near high voltages should be familiar with methods of resuscitation.

DANGER

Disconnect Power for Service! Always disconnect all power sources following proper lock-out tag-out procedures before performing service, repair or test operations. Remove the tethered hand held control where applicable for added protection during maintenance.

⚠ DANGER

Mast Tip Over Hazard! Mast tip over could result in death or serious injury. Before operation, be certain mounting structure is capable of resisting forces generated from all loading and environmental conditions, including, but not limited to, mast size and weight, payload and cable size and weight, payload sail area, wind speed, guy line arrangement, support bracket or roof line location, and base plate assembly. Do not operate in wind speed conditions exceeding the maximum rated wind speed. Do not operate on slopes exceeding the maximum deployment angle. Do not install a payload that exceeds the maximum payload lifting capacity of mast. Do not install a payload with the center of gravity offset from mast centerline exceeding the maximum allowed offset. Stand clear of mast and mast payload during operation. Be certain mast is level and secure before and during installation, operation, and maintenance.

⚠ DANGER

Falling Objects from Mast Hazard! Wear a protective hard hat when working on mast or situated near mast operating area while mast is extending, retracting or deployed in any position above the nested position. Improperly secured payload or mast components, ice formations, etc. could be dislodged from mast and fall. Be sure the payload is properly installed and secured.

⚠ DANGER

Relocation/Driving Hazard! Do not relocate the system during operation or while mast is extended to any height above the nested position or powered up. Do not move vehicle until mast has been securely nested and isolated from power. Power-up and operate mast only if the vehicle is stationary and securely parked with the parking brake properly applied. Do not put mast in service or operate without the vehicle interlock warning circuit or magnetic warning kit installed to provide confirmation mast is nested prior to moving the vehicle. Contact The Will-Burt Company Engineering for special on-the-move situations for military only use on specialized products.

⚠ DANGER

Burst Hazard! For pneumatically operated masts, do not operate without the over-pressure safety valve installed. Keep personnel clear of safety valve exhaust direction. Do not exceed the maximum rated pressure of mast. If the mast air pressure is not fully discharged prior to removing air hoses, a rapid release of air pressure will occur requiring hearing and eye protection.

⚠ WARNING

Payload Lifting Hazard - Intended Use! The mast is intended to lift a specific payload for lighting, surveillance or communication use only. Any other use without written consent is prohibited and could cause death or serious injury. Do not use mast to lift personnel. Do not exceed specified payload capacity. Large payload wind sail areas can reduce payload capacity. Consult The Will-Burt Company engineering.

⚠ WARNING

Read Operating Instructions! Read and observe the operating instructions. Non-observance of the instructions, operation which is not in accordance with use as prescribed in the instructions, wrong installation or incorrect handling can seriously affect the safety of operators and machinery. Adhere to the safety instructions when carrying out any activity relating to the Ranger™ Mast.

⚠ WARNING

Trained Personnel Only! This product is intended for use by trained professionals only. It is not intended for general use by the public or untrained personnel. Handling, installation, operation and maintenance to be performed by trained and authorized personnel only. Only a properly trained and qualified certified electrician should perform electric installations and service.

⚠ WARNING

Erratic Mast Operation Impact Hazard! The mast should operate smoothly during extension and retraction. If erratic mast motion is observed during extension or retraction that results in impact loading between the tube and the tube collar (mechanical travel stop), cease use of the mast and contact The Will-Burt Company service department. Repeated operation with impact loading can damage tubes and lead to mast separation.

⚠ WARNING

Over-current Protection! Over-current protection or power switching by the installer on mast incoming power supply as specified in this document should be a type suitable to allow lock-out tag-out procedures for power disconnect.

⚠ WARNING

Safety Instruction - Explosion! For outdoor use only. Do not use in explosive areas or areas that have been classified as hazardous as defined in Article 500 of the National Electric Code or equivalent national standards. Do not use in the presence of flammable gases or liquids such as paint, gasoline or solvents. Do not use in areas of limited ventilation or where high ambient temperatures are present.

⚠ WARNING

Safety Equipment (PPE)! Proper personal protective equipment (PPE) like hard hats, gloves, and safety shoes shall be properly worn while working on mast or near the deployment area of mast. In addition, eye protection shall be worn during maintenance procedures. Follow national PPE guidelines in your area of operation.

⚠ WARNING

Pinch Point Hazard! Keep clear of all moving parts like mast collars nesting. Be sure to stay clear of system during operation. Moving parts can crush and cut resulting in serious injury. The mast shall be mounted out of reach of the operator during operation.

⚠ WARNING

Crush Hazard - Mast Failure! Do not stand directly beneath mast or its payload. Be certain the payload is properly installed and secured.

⚠ WARNING

Entanglement Hazard! Tangled cables can cause equipment damage. Ensure payload cables, Nycoil®, trip lines, guy lines or other cables are not tangled and are free to pay out as mast is deployed. Cables that get tangled or snagged on mast or other objects can cause mast tubes to lurch upward suddenly when the cable is freed. This can cause damage to mast and lead to mast separation if repeatedly allowed to continue.

⚠ WARNING

Health and Safety Hazard while Cleaning! Solvent used to clean parts is potentially dangerous. Avoid inhalation of fumes and prolonged contact to skin.

⚠ WARNING

Fire Hazard Solvent! Cleaning solvent, used for maintenance, is flammable and can be explosive. Do not smoke near solvent. Use cleaning solvent in a well-ventilated area. Keep cleaning solvent away from ignition sources. Always store cleaning solvent in the proper marked container and in a proper location.

⚠ WARNING

Bright Light Radiation Hazard! For systems equipped with scene lighting or look-up lights, do not look directly into lights when they are illuminated. Temporary impairment or permanent vision damage could occur.

⚠ WARNING

Personnel Freezing/Burn Hazard! If the system is equipped with lights, make sure the lights are completely cool before attempting to clean the lens, replace bulbs or perform maintenance. Wear gloves to protect from contact with exposed metal that may be at extremes of hot and cold temperatures from sun or cold outdoor exposure.

⚠ WARNING

Mast Extension Hazard - Obstruction! Extending mast into obstructions could result in death or serious injury and could render mast inoperable and partially extended. Before applying power and operating mast, be certain there is sufficient clearance above and to all sides of the expected location of the fully extended mast and payload. Keep all persons clear of mast and mast extension. Do not lean directly over mast. Locate the operator station such that the operator has a clear view of the operating space of mast and payload prior to deployment to avoid contact with overhead objects.

⚠ WARNING

Manual Retraction! For powered masts, make sure all power sources have been disconnected from the system prior to manually lowering mast to avoid unexpected start-up motion and/or damage to mast.

⚠ WARNING

Mast Lifting/Handling! Use extreme caution while lifting mast System and when mast System is suspended to avoid injury and equipment damage. Be certain mast is properly secured using at least two sling points at the center of gravity label. All operators should be aware of and follow the applicable local, regional, and national standards and codes of practice for slinging and transporting equipment. Never lift Mast System over people. Ensure lifting equipment including, but not limited to, lifting straps and hoist, are capable of handling the forces generated from lifting the system. Observe manufacturer instructions on lifting equipment.

⚠ WARNING

Remove Payload! For mast systems shipped with no payload (customer installed payloads), remove payload before performing maintenance on mast system. The Will-Burt Company installed devices can remain installed.

⚠ WARNING

Equipment Damage - Submerged! Do not submerge mast in liquid or operate the vehicle in a fording situation that would result in a submerged mast.

⚠ WARNING

Safety Instruction – Keep Clear! Keep personnel clear of the system during operation.

⚠ WARNING

Safety Instruction - Potential Air Contaminants! If internally mounted in a vehicle, air from mast and any accumulated water will discharge into the vehicle. Install appropriate drainage and venting.

⚠ WARNING

Fastener Vibration Hazard! Mast system and payload mounting hardware must include proper means to resist vibration loosening such as thread-locking compound, locking hardware, or equivalent. Use specified assembly torques appropriate for the fastener size.

⚠ CAUTION

Safety Instruction - Guy Anchors! For masts using Guy Lines, verify the Guy Anchor point strength is adequate to support the Guy Line forces.

⚠ CAUTION

Frozen Water Hazard! Water freezing inside mast or air fittings may render mast inoperable and cause major equipment damage such as tube deformation. Ensure water is free to exit at the base of mast. Open drain cock when mast is not in operation. The drain cock shall be installed at the lowest position in the pneumatic system. If mounted internally in a vehicle or structure, direct the draining water to a suitable location. Cover locking masts when not in use to limit water ingress. Non-locking masts stored outdoors should be covered if possible. A cover is available from The Will-Burt Company.

⚠ CAUTION

Lubrication! Do not lubricate the exterior of mast moving tubes. The lubricant will attract dust and other environmental contaminants into mast.

⚠ CAUTION

Equipment Damage - Forces! Before unloading the system, be certain the unloading region is capable of resisting forces generated from unloading the system including but not limited to system weight. Ensure the unloading region is level and has sufficient room and strength to hold the system. If the unloading region is incapable of meeting the requirements of the system, damage to the system and/or unloading region could occur.

⚠ CAUTION

Equipment Damage - Support Bracket! For masts using an upper support bracket, do not over-tighten mast support bracket. Over-tightening may damage the Base Tube causing mast tubes to stick.

⚠ CAUTION

Mast and Payload Access! The operator must provide safe means to access mast and payload during installation, removal and maintenance.

⚠ CAUTION

Tripping Hazard! Cables, trip lines, guy lines and guy anchors can be hard to see during and after installation. Any equipment posing trip hazards should be clearly marked.

⚠ CAUTION

Lifting Hazard! Manually lifting over 55 lb. (25 kg) is prohibited. In the UK, all lifting equipment must be thoroughly examined annually by a competent person according to the Lifting Operations and Lift Equipment Regulations 1998. Equivalent regulations exist in other EU states.

⚠ WARNING

Mast Extension Hazard - Obstruction! Do not deploy the mast if power lines are less than 80 ft. (24.4 m) from the center of the deployment site.

⚠ WARNING

Mast Tip Over Hazard! Do not attempt to deploy or retrieve this mast when winds exceed 32 km/h / 20 mph.

⚠ WARNING

Mast Deployment Hazard! Do not attempt to deploy the tripod on ground that slopes more than 2°. Do not attempt to deploy the mast on soft or loose soil. The base plate and guy stakes could become unstable under wind loading and cause the mast to fall. The mast must be vertical before deployment. Adjust guy lines as required until the bubble level indicates the mast is vertical.

⚠ CAUTION

Safety Instruction - Guy Stakes! Use guy stakes to secure tripod and mast. For masts 8 ft / 2.4 m to 40 ft / 12.2 m tall and smaller payloads, one stake per tripod leg plate may be sufficient. For masts taller than 40 ft / 12.2 m, two stakes are required on each tripod leg plate. Be mindful of buried cables when staking the mast. Always follow guy stake removal instructions to avoid injury and/or guy stake damage.

The following list contains reasonably foreseeable misuses of the mast system according to EN ISO 12100 5.3.2. These uses shall be avoided:

- Operating the mast with an obstruction in the functional space that prevents full extension or retraction
- Operating the mast near overhead power lines
- Operating the mast without the mast and operating space visible to the operator
- Driving the vehicle with the mast in a deployed position (any height above the nested position) or powered-up
- Operating the mast or leaving deployed in wind speeds higher than the specified maximum velocity
- Operating the mast on a non-level surface greater than the specified maximum angle
- Installing a payload greater than the maximum rated payload (weight and sail area) of the mast

1.3 Symbols

The following are symbols that are used with the system and their meaning. Contact The Will-Burt Company with any questions before performing any procedure outlined in this manual.



This symbol indicates an electrocution hazard or hazardous voltage hazard. There is DC voltage present inside the mast and control box. Do not operate mast near electrical lines or during lightning events. Contact with high voltage will result in death or serious injury.



This symbol indicates a pinch point hazard. Keep fingers and hands clear of moving parts.



This symbol indicates a tip-over hazard. The mast must be properly supported during transport, installation, maintenance and operation. System tip-over could result in death or serious injury.



This symbol indicates a general warning. In this unit, this symbol indicates a frozen water hazard. Do not block the mast drain port at the base of the unit. Water must be permitted to exit the mast to avoid ice damage to the mast.



This symbol is used to remind users to read and understand the operator's manual before operating the Mast System. Failure to follow operating instructions could result in death or serious injury. Read and understand operator's manual before operating or installing the mast system.



This symbol indicates a hard hat is required when working under the mast operating area. Failure to wear a hard hat could result in death or serious injury.



This symbol indicates an electrical ground connection point.



This symbol is used to indicate the center of gravity (COG) of a fully nested mast.

Section 2 Introduction

Thank you for selecting The Will-Burt Company for your critical payload elevation needs. These operating instructions describe transporting, handling, installing, disassembling, maintaining and storing procedures for the Ranger™ Mast. These procedures assume the use of standard mast systems. Procedures and characteristics for mast systems customized to meet customer-specific needs may vary.

These operating instructions are intended for professionals who are qualified by their appropriate training and experience to perform the procedures. Review this document in its entirety. Contact The Will-Burt Company with any questions before performing any procedure outlined in this manual.

The views depicted in this manual are provided for clarification and are subject to change without notice. Views are not to scale.

The Ranger™ Mast is a man-portable, field-erected mast designed for ease of use while delivering payload deployment flexibility and rugged reliability. The Ranger™ Mast is a fast and easy solution for elevating a variety of payloads, including lighting, cameras and antennas. The masts are lightweight and can be manually transported and deployed by one, two, or three people. The Ranger™ Mast is available in 2 in / 50.8 mm diameter and maximum height of 60 ft / 18.3 m. The following models are covered in these operating instructions:

- Ranger™ Mast
- Ranger™ Mast with the EZ Raze™ option

See www.willburt.com for information on these and other The Will-Burt Company products.

The Ranger™ Mast is available with many options installed by The Will-Burt Company, such as different payload adaptors. By adding accessories, the mast can be configured with 2, 3, or 4 arms in 6, 12, 24, or 36 in (15, 30, 60 cm or 1 m) lengths. If using the mast with the EZ Raze™ option, the mast can be configured with 2, 3, or 4 arms in 24 in to 48 in (61 cm to 122 cm) lengths.

2.1 Intended Use

The Ranger™ Mast is intended for use by professionals in the fire/rescue/first responder/security/towing/broadcast/cellular industries to provide elevated and directional emergency scene lighting and surveillance or communication capabilities. It is not intended for use by nonprofessionals. Do not use the mast to lift personnel. Contact The Will-Burt Company with any questions on the intended use or available training programs for the Ranger™ Mast.

2.2 Definitions

The following terms are used throughout this manual:

- **Mast:** refers to the telescoping Ranger™ Mast
- **Mast System:** refers to the entire mast system and other optional accessories
- **Payload:** refers to the object or equipment being extended by the mast to an operational height

2.3 Mast Component Descriptions

This section describes major components of a mast system assuming the use of standard catalog mast systems. Characteristics of components customized to meet customer-specific needs may vary. If necessary, contact The Will-Burt Company for additional details.

The exact configuration of the mast may vary. For detailed information on the locations of components in your system, see the drawings that shipped with the system.

Table 2-1 is a summary of mast components. Table 2-2 is a summary of mast components with the EZ Raze™ option.

Table 2-1 Mast Components

Accessory Bag	QTY	Description
Guy Bag	8	Guy Line Stakes
	4	Guy Ropes
	1	Guy Stub
	1	Lift Puck
	1	Hammer
Tube Bag	2	Section tubes for 12'
	3	Section tubes for 16'
	4	Section tubes for 20'
	5	Section tubes for 24'
	6	Section tubes for 28'
	7	Section tubes for 32'
	8	Section tubes for 36'
	9	Section tubes for 40'
	10	Section tubes for 44'
	11	Section tubes for 48'
	12	Section tubes for 52'
	13	Section tubes for 56'
	14	Section tubes for 60'
	Short Bag	4
1		Tripod Step
1		Operator's Manual
Long Bag		Empty
Wheeled Bag	1	Guy Bag
	1	Long Bag
	1	Tube Bag
	1	Short Bag
	1	Tripod
	1	Base Tube
	1	Top Tube

Table 2-2 Mast Components with EZ Raze™ Option

Accessory Bag	QTY	Description
Guy Bag	8	Guy Stakes
	4	Guy Ropes
	1	Lift Puck
	1	Hammer
Tube Bag	3	Section tubes for 16'
	4	Section tubes for 20'
	5	Section tubes for 24'
	6	Section tubes for 28'
	7	Section tubes for 32'
	8	Section tubes for 36'
	9	Section tubes for 40'
	10	Section tubes for 44'
	11	Section tubes for 48'
	12	Section tubes for 52'
	13	Section tubes for 56'
Short Bag	14	Section tubes for 60'
	2	Side Brackets
	1	Top Pulley/Guy Tip
	1	Carriage
	1	Winch Handle
	4	Base Plates
	1	Tripod Step
1	Operator's Manual	
Long Bag	2	Extension Arms
	2	Cup Holders
	1	Bolster Plate
Wheeled Bag	1	Guy Bag
	1	Long Bag
	1	Tube Bag
	1	Short Bag
	1	Tripod
	1	Winch Base Section

Telescoping Mast (arrives disassembled): The telescoping mast is the structure used to raise the payload to an operational level. The mast consists of a base tube, intermediate tubes, and a top tube. If using the EZ Raze™ option, the mast consists of a winch/base tube, intermediate tubes, and a tip tube.

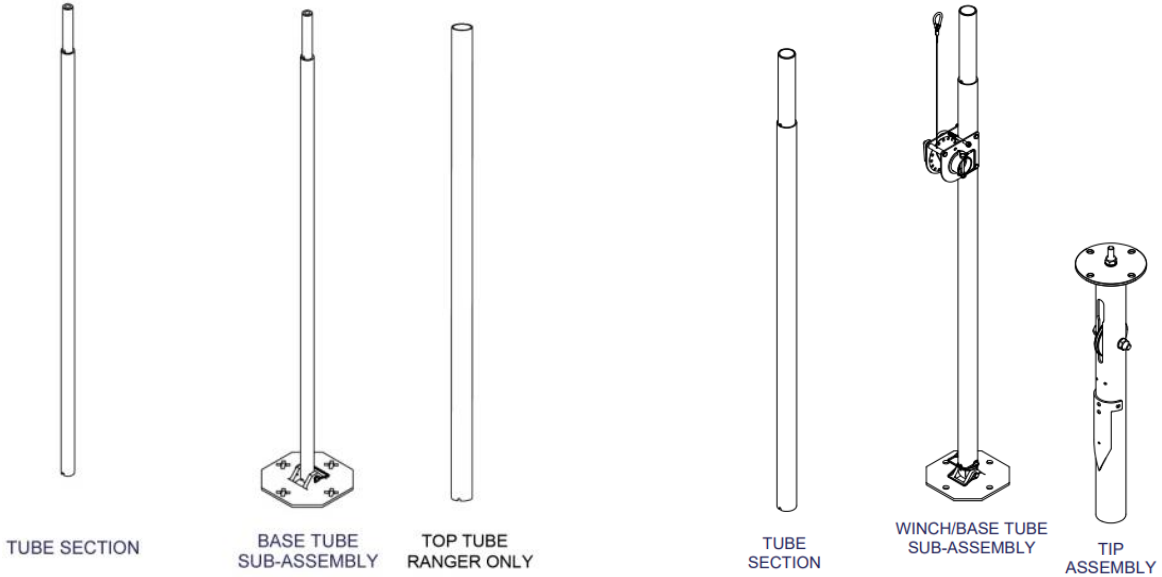

Ranger Tubes

Ranger with EZ Raze Option Tubes

Figure 2-1 Telescoping Mast Parts (Not to Scale)

Tripod: The tripod stabilizes and connects the mast to the mounting location. The tripod is vital to keeping the mast stable during deployment.

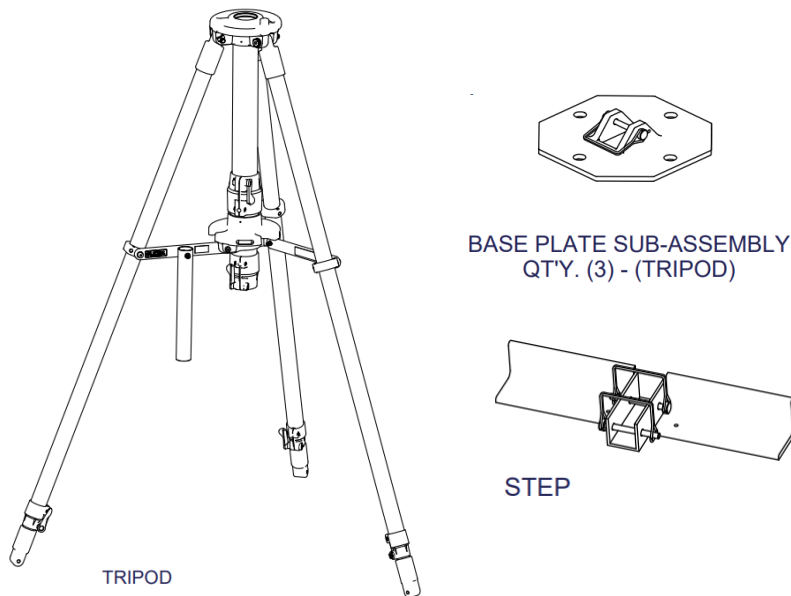

Figure 2-2 Tripod, Base Plate Assembly and Tripod Step

Guy Bag: Contains the guy line stakes (8), guy ropes (4), guy stub (1), lift puck (1), hammer (1).

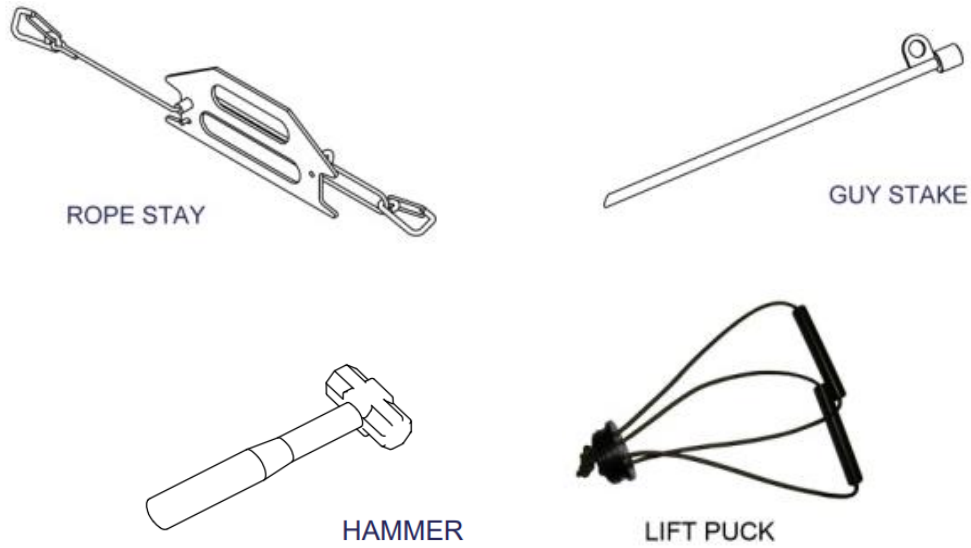

Figure 2-3 Some Guy Bag Components (Not to Scale)

Guy Collars: Used to attach the guy lines to the top of the mast.

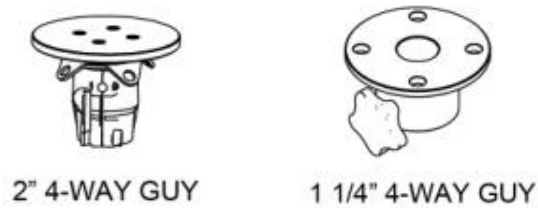

Figure 2-4 Guy Collars

Wheeled Bag: The wheeled bag is a carrier for the mast, tripod, guy bag, long bag, tube bag, short bag, and other components.

EZ Raze™ (Optional): The EZ Raze™ option is a high-capacity winch, pulley and payload carriage system. Once the mast is installed, this optional system permits a single person to raise multiple antennas and equipment weighing up to 40 lb. / 18.1 kg (when evenly distributed) in a safe and controlled manner. The EZ Raze™ Option mast can be configured with 2, 3, or 4 arms in 24 in / 61 cm to 48 in / 122 cm lengths.



Figure 2-5 EZ Raze™ Option Non-Deployed

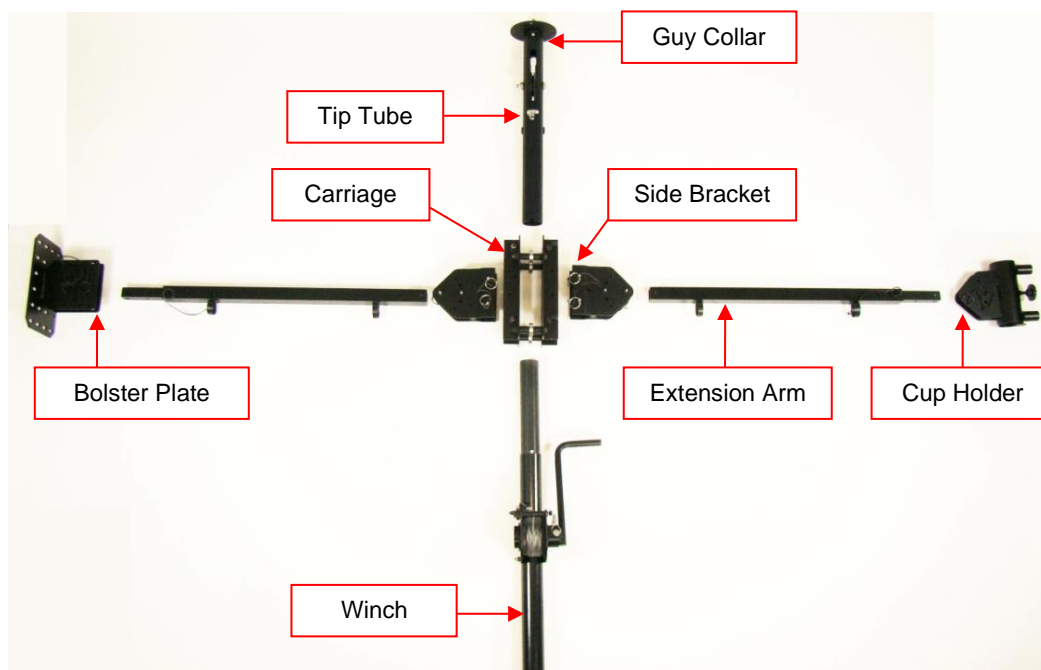
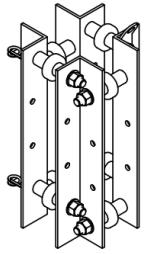
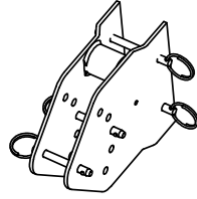
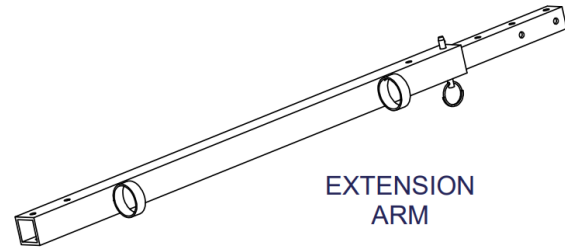

Figure 2-6 EZ Raze™ Option Disassembled



CARRIAGE

SIDE
BRACKETEXTENSION
ARM*Figure 2-7 Some EZ Raze™ Option Components*

Payload Adaptors (Optional): Payload adaptors attach to the top of the mast and are used to secure and support the payload during operation. Payload adaptors come in varying sizes and configurations. It is possible to guy directly to some payload adaptors. Optional payload adaptors offered are:

- Bolster Plate: Used to secure a payload with U-bolts or with a payload plate
- Cup Holder: Used to secure whip antennas one to two inches in diameter
- NATO plate
- Blank plate

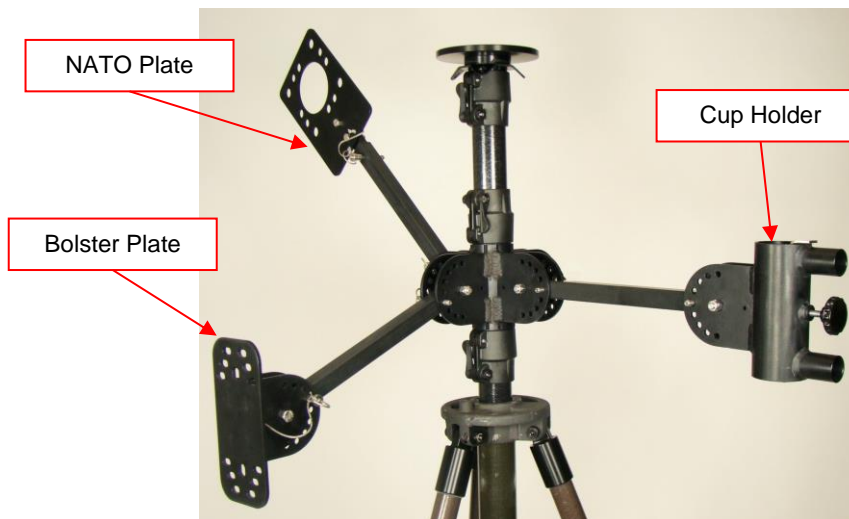
*Figure 2-8 Accessories (Bolster Plate, NATO Plate and Cup Holder Shown)*

Section 3 Technical Data

The model numbers listed in this section are for catalog masts with a black anodized finish only. Masts with other heights, capacities, and finishes are available. For more information on additional mast sizes, capabilities, and finishes, see www.willburt.com.

3.1 Payload Capacity and Wind Effects

The maximum payload for the mast is 40 lb. / 18.1 kg total and 20 lb. / 9 kg maximum per arm. The payload weight should be evenly distributed between arms on the mast. For example, if you have 4 arms and a total payload of 40 lb. / 18.1 kg, place 10 lb. / 4.5 kg on each arm. Furthermore, payloads of 30 lb. / 13.6 kg and 8 lb. / 3.6 kg are not supported even though the total payload is 38 lb. / 17.2 kg since the maximum payload weight per arm is 20 lb. / 9 kg. The cable weight must be considered in the maximum payload weight. If the cable weight is significant, it may be possible to route the cable opposite the payload weight or to loosely wrap the cable around the tubes.

Note: Do not deploy the mast in winds greater than 32 km/h / 20 mph. For payload weights and wind sail areas outside website specified limits, contact The Will-Burt Company.

Table 3-1 Ranger™ Mast Specifications

Ranger™ Mast Specifications						
				Optional EZ Raze™ System		
Model	Weight	Height	Rated Payload Capacity *	Model EZ Raze	Weight w/ EZ Raze	Payload Capacity
714071200	56 lb.	12 ft.	40 lb.	N/A	N/A	N/A
	26 kg	3.7 m	18 kg			
714071600	58 lb.	16 ft.	40 lb.	714171600	84 lb.	40 lb.
	26.5 kg	4.9 m	18 kg		38 kg	18 kg
714072000	60 lb.	20 ft.	40 lb.	714172000	86 lb.	40 lb.
	27.5 kg	6.1 m	18 kg		39 kg	18 kg
714072400	63 lb.	24 ft.	40 lb.	714172400	89 lb.	40 lb.
	29 kg	7.3 m	18 kg		40.5 kg	18 kg
714072800	69 lb.	28 ft.	35 lb.	714172800	91 lb.	40 lb.
	29.5 kg	8.5 m	16 kg		41.5 kg	18 kg
714073200	68 lb.	32 ft.	30 lb.	714173200	94 lb.	40 lb.
	31 kg	9.7 m	14 kg		43 kg	18 kg
714073600	70 lb.	36 ft.	25 lb.	714173600	96 lb.	40 lb.
	32 kg	11 m	11 kg		44 kg	18 kg
714074000	73 lb.	40 ft.	20 lb.	714174000	99 lb.	40 lb.
	33 kg	12.2 m	9 kg		45 kg	18 kg
714074400	79 lb.	44 ft.	15 lb.	714174400	105 lb.	40 lb.
	36 kg	13.4 m	7 kg		48 kg	18 kg
714074800	82 lb.	48 ft.	10 lb.	714174800	108 lb.	40 lb.
	37 kg	14.6 m	4.5 kg		49 kg	18 kg
714075200	84 lb.	52 ft.	10 lb.	714175200	110 lb.	35 lb.
	38 kg	15.8 m	4.5 kg		50 kg	16 kg
714075600	87 lb.	56 ft.	5 lb.	714175600	113 lb.	35 lb.
	40 kg	17 m	2.2 kg		51.5 kg	16 kg
714076000	90 lb.	60 ft.	5 lb.	714176000	115 lb.	30 lb.
	41 kg	18.3 m	2.2 kg		52.5 kg	14 kg

Specifications are for reference only and are subject to change. Please contact Will-Burt Engineering for current and exact specifications.

*Additional Payload Capacity – Consult Factory for max payload

*Payload Capacity Total = EZ Raze™ and center mast payload

*All models include standard 1 level / 4 way guylines

Section 4 Installation

This section provides instructions for installing the mast system and provides the general procedures that must be followed to ensure a successful installation. Be sure to read and understand the entire installation procedure and the Safety Summary (Section 1) before beginning installation.

4.1 Pre-Installation Check

Before installing the mast system, ensure:

- All installers read and understand the entire installation procedure and are properly trained.
- Only a properly trained and qualified certified electrician performs electric installations and maintenance.
- The mounting structure is level and has sufficient room and strength to mount the mast system.
- All purchased components are included (Section 2.3).
- All required equipment is readily available (Section 4.3).

Check with The Will-Burt Company's Engineering for additional wind information for customer-specific loading scenarios.

4.2 Select a Suitable Mounting Location

To select a suitable mounting location, consider the following:

- Select a flat, level site to deploy the system that has no more than a 2° slope. The ground should be level and firm.
- Ensure that the center of the site is approximately 2 sq. ft. and is level and smooth. The center of the site is where the base tube for the mast will land later in the installation.
- Select an area free of power lines or other overhead obstructions. Ensure that the site has adequate overhead and ground clearances. The overhead clearance must be at least the height of the mast.
- The ground clearance must be a radius equal to the height of the mast. For example, for a 12 ft / 3.7 m mast, ensure that the site has an overhead clearance of 12 ft / 3.7 m and a clear radius of 12 ft / 3.7 m from the center of the site.

4.3 Recommended Installation Tools

Table 4-1 lists recommended tools and materials for installation.

Table 4-1 Tools and Materials Required for Installation

Tools and Materials		
Safety Glasses	Safety Shoes	Nitrile or Vinyl Gloves
Hearing Protection	Hard Hat or Helmet	Safety Gloves / Work Gloves
Level (Optional)	Plumb Bob (Optional)	Measuring Tape (Optional)
Note: Depending on the national and local standards and codes of practice, and the environment, additional personal protective equipment may be necessary.		

4.4 Unpack the Mast System

Unpack and handle the mast as follows:

1. Carefully open shipping container.
2. Remove all loose parts.
3. Ensure all components are included (Section 4.3) and that the required tools (Section 4.3) are readily available.
4. Carefully lift the wheeled bag and other components free from the shipping container.
5. Inspect for any shipping damage. If damage has occurred, notify the carrier.
6. Unzip the wheeled bag and remove the tripod and base tube.



Figure 4-1 Unzip the wheeled bag and remove the tripod and base tube.

7. Open the guy bag.

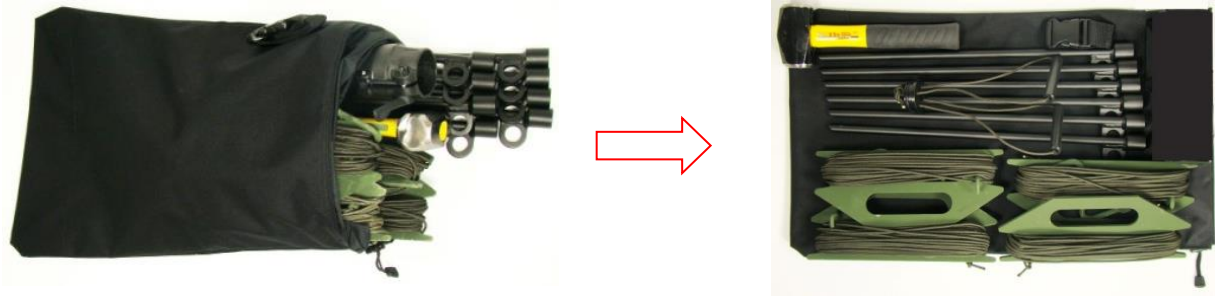

Figure 4-2 Open the guy bag

8. Open the short bag.



Figure 4-3 Open the short bag

9. Open the tube bag.

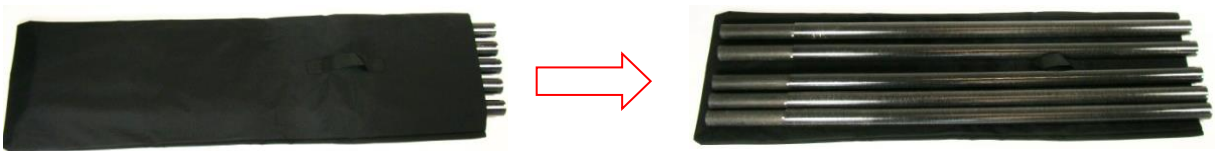

Figure 4-4 Open the tube bag

The Will-Burt Company recommends keeping the shipping container for transporting the mast, for example if shipping the mast back to the factory for refurbishment.

4.5 Set Up the Tripod

Set up the tripod as follows:

1. There are five clamps on the tripod. Three clamps are on the tripod legs and two clamps are in the center of the tripod. To unlock a clamp, push the lever towards the open position away from the locking tab. To lock a clamp, push the lever to the closed position and towards the locking tab. When locking a clamp, ensure that the lever locks into place on the tab. The clamps hold the weight of the mast and payload. See Section 7.5 to check that the clamps are sufficiently tight.

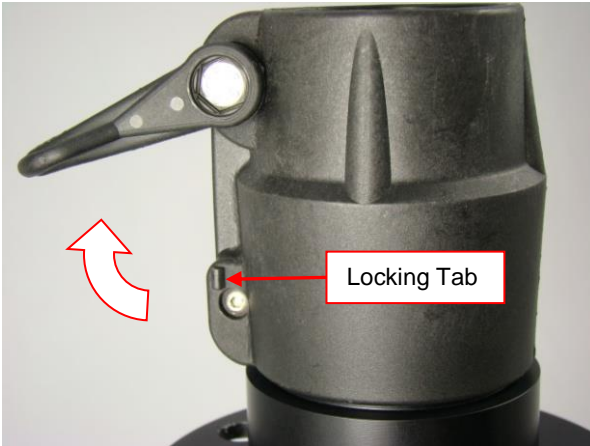

Figure 4-5 Unlocking



Figure 4-6 Locking

10. Loosen the Velcro strap from around the tripod legs. With the tripod on the ground, attach three base plates to the three tripod legs by pushing the hitch pin through the leg and securing the other end.

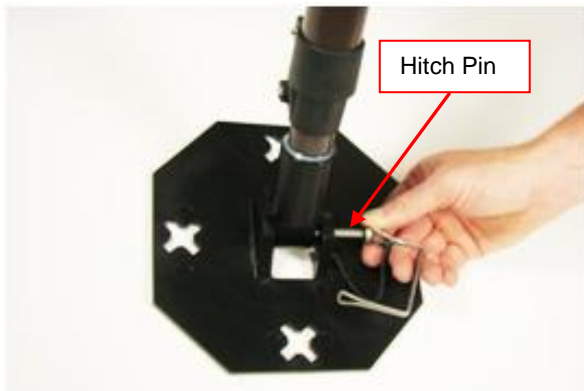

Figure 4-7 Insert Hitch Pin



Figure 4-8 Secure Hitch Pin

11. Lift the tripod and unlock the upper clamp. This unlocks the tripod.



Figure 4-9 Stand Up Tripod

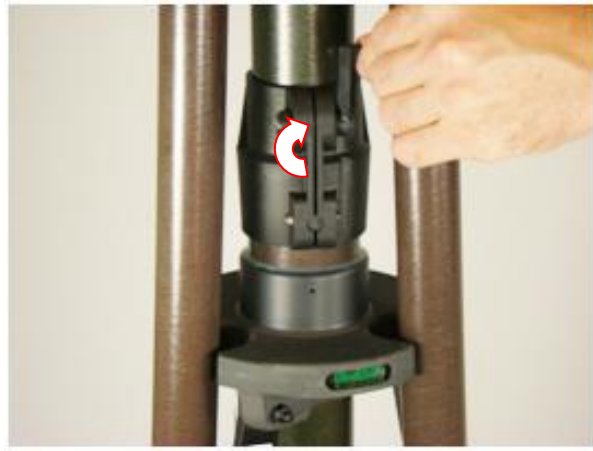

Figure 4-10 Unlock

12. Open the tripod by pushing down on the center collar, keeping fingers away from the pinch points. Push down on the collar until the collar hits the stop and the base plates are flat on the ground.



Push Down



Collar Hitting Stop

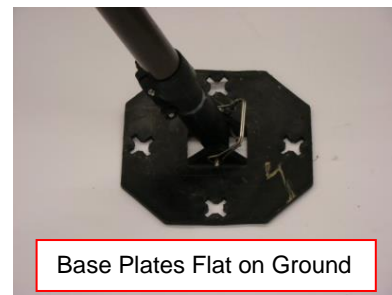

Base Plates Flat on Ground

Figure 4-11 Open the Tripod

Partially Raise the Tripod Legs:

- Partially raise the tripod leg to ensure that the tripod is at a comfortable working height for attaching any accessories (including the carrier if using the EZ Raze option) and the payload in the later steps. With one person on each of the legs, unlock the leg clamp, step on the leg base, and lift the tripod until the tripod collar is about waist high. Lock the leg clamps.

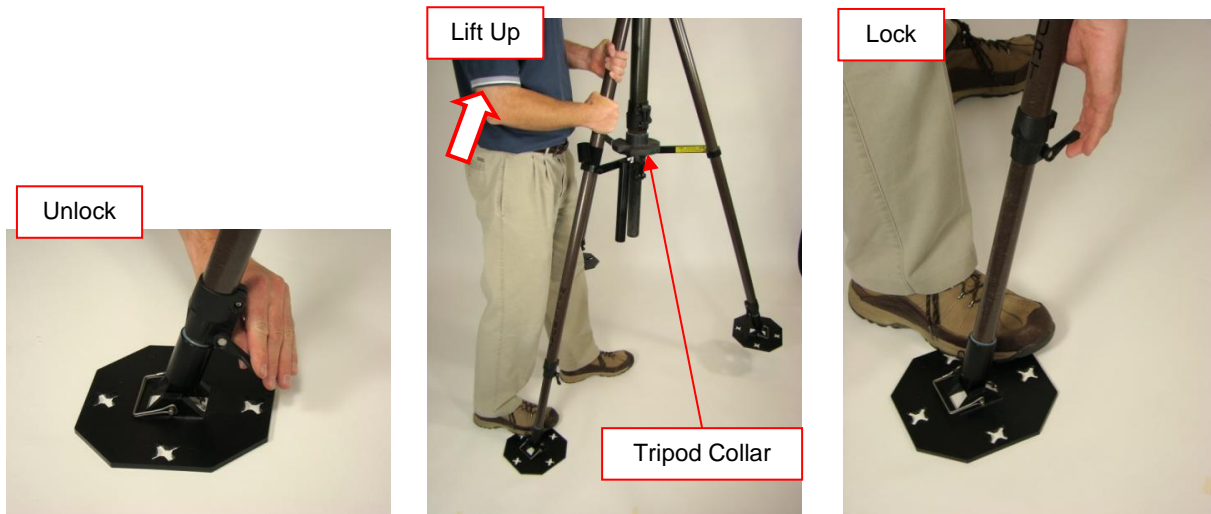

Figure 4-12 Partially Raise the Tripod Legs

4.6 Deploy the Mast

This section describes how to deploy the mast system. The exact deployment procedures will vary based on the configuration of your mast system. Follow the appropriate deployment procedures for your mast system.

Ensure the proper personnel are available to deploy the mast:

- 2.4m / 8 ft. to 12.2m / 40 ft. mast:** Depending on the payload weight and the current wind speeds at deployment, two to three people are required to raise the mast. One person is typically required to load the mast tubes while one to two people manage the guy lines. Typically, single staking the tripod base plates is sufficient.
- 13.4m / 44 ft. to 18.3m / 60 ft. mast:** Depending on the payload weight and the current wind speeds at deployment, three to five people are required to raise the mast. One to two people are required to load the mast tubes while two to three people manage the guy lines. Double staking the tripod base plates is required. For taller masts, binoculars may be required.

Ensure the mast is only being operated in safe wind speeds. Deployment and retraction wind speeds are payload dependent, however, the mast can typically be deployed and retracted in winds speeds up to 20 mph (32 km/h) assuming deployment angle is 2° of vertical.

4.6.1 Manual Deployment

To deploy the mast manually:

4.6.1.1 Install the Top of the Mast

Insert the Top Tube

1. Stand in the operator's quadrant. This area is next to the winch holder and in front of one of the levels. Lock the upper clamp. See Section 7.5 to check that the clamp is sufficiently tight. Unlock the lower clamp.



Figure 4-13 Lock the Upper Clamp and Unlock the Lower Clamp

2. Retrieve the top tube (no tapered end (Section 2.3)) from the tube bag. Insert the top tube from the top of the tripod. Ensure that the white knob, upper clamp, and lower clamp are in a straight line. See Section 7.5 to check that the clamps are sufficiently tight.

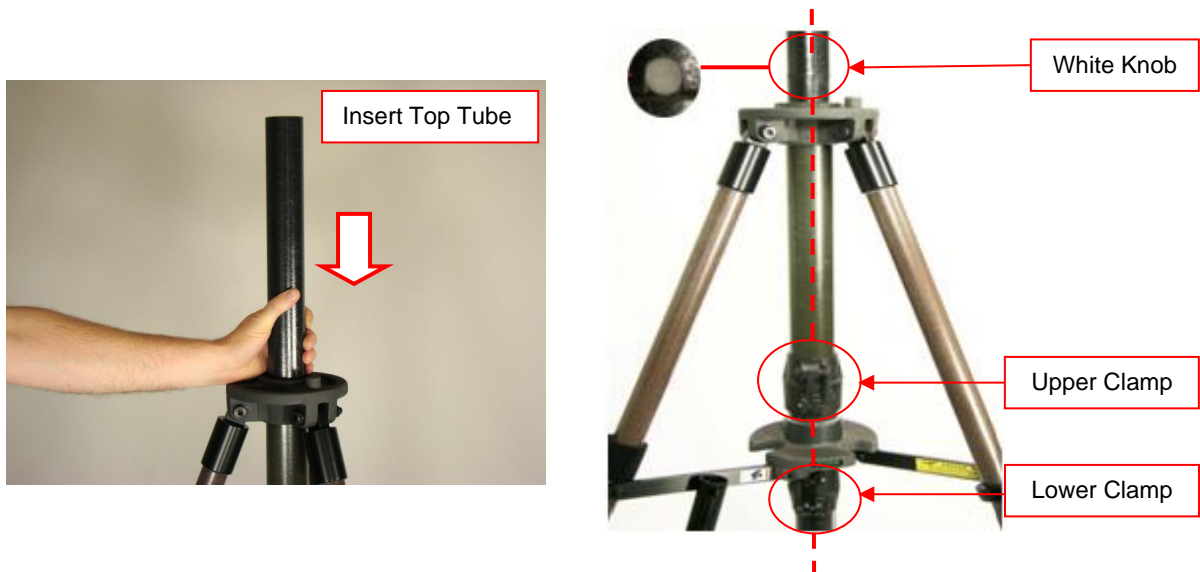

Figure 4-14 Insert Top Tube from the Top of the Tripod

3. Lower the top tube until there is one hand width from the bottom of the tube and lock the lower clamp.

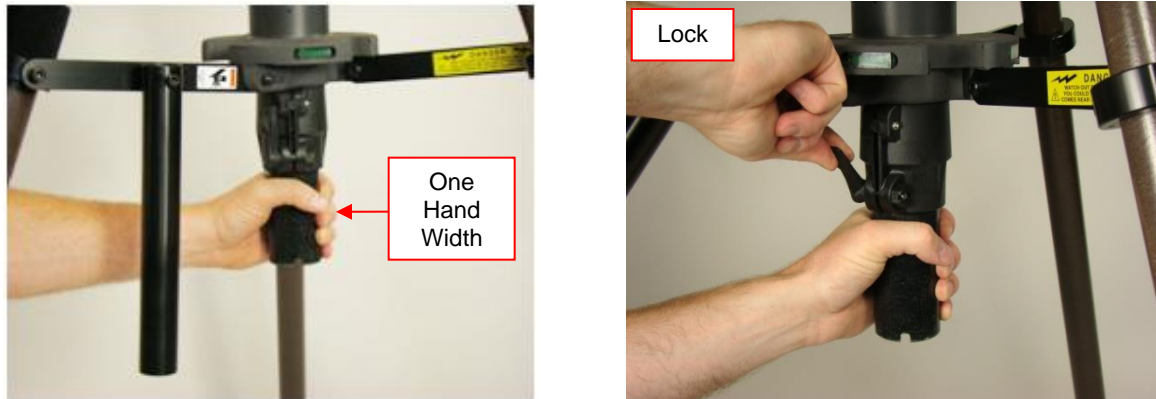

Figure 4-15 Lower Top Tube Until There is One Hand Width from the Bottom of the Tube and Lock the Lower Clamp

4. If installing accessories onto the mast, different collars and the accessories must be installed. Proceed as follows:
 - If installing just the mast, continue with Step 5.
 - If installing the accessories along with the mast, go to Step 8.

Install the 4-Way Guy Collar

5. Unlock the 4-way guy collar (2 in / 50.8 mm or 1 ¼ in / 31.8 mm) and place the guy collar onto the top of the top tube. Connect the payload to the top of the payload stub. For payload weights and wind sail areas outside website specified limits, contact The Will-Burt Company.



Figure 4-16 Unlock the 4-Way Guy Collar and Place the Guy Collar onto the Top Tube

6. Rotate the guy collar so that the four guy lines will land on the ground where desired.

7. Lock the guy collar clamps. If accessories are not going to be installed, go to Step 17.

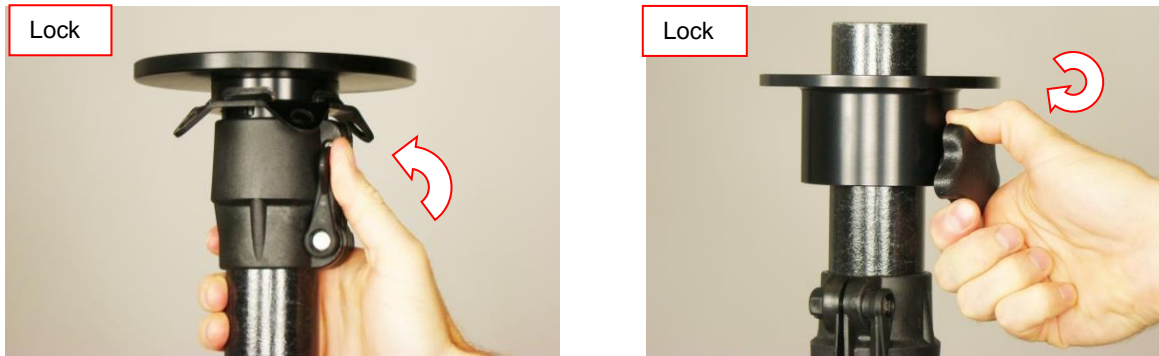

Figure 4-17 Lock the Guy Collar Clamps

Install Accessory Arm Collar

8. Slide the arm collar onto the top tube.

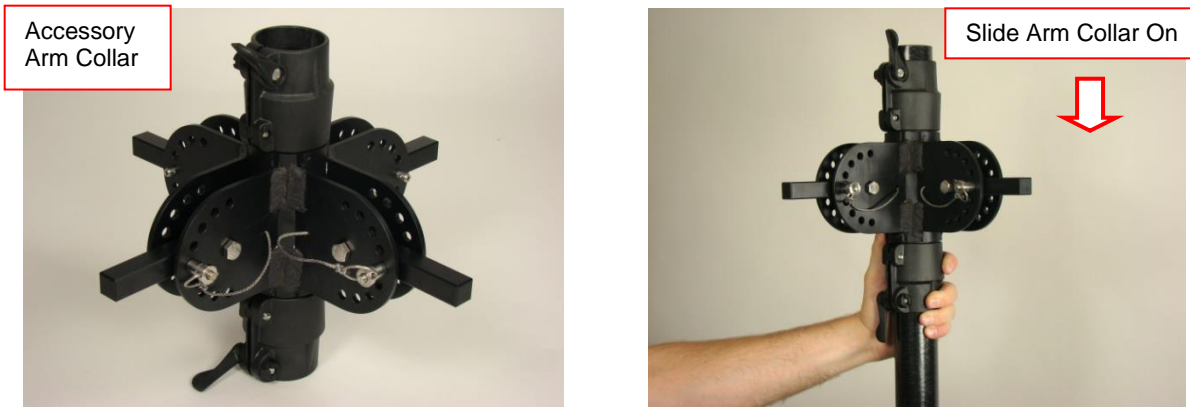

Figure 4-18 Slide Arm Collar onto Top Tube

9. Lock the top and bottom clamps. See Section 7.5 to check that the clamps are sufficiently tight.

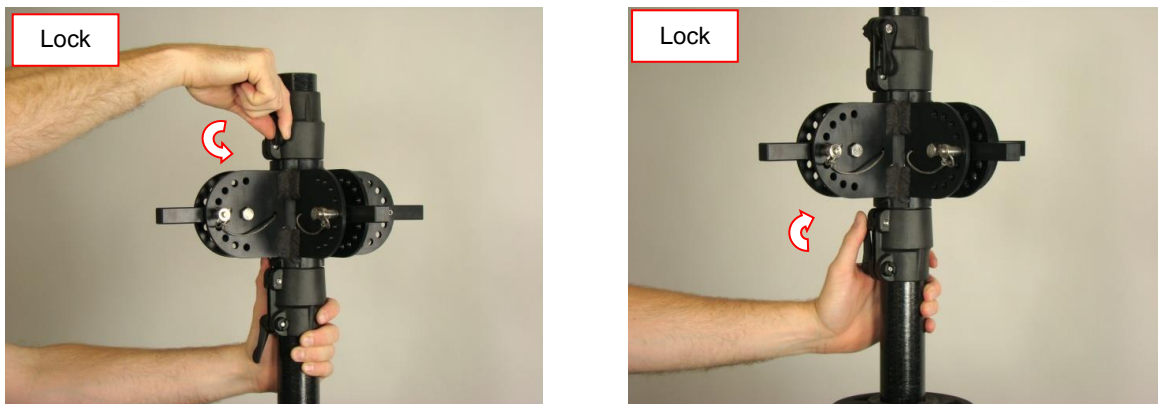

Figure 4-19 Lock Top and Bottom Clamps

10. Pick an angle for the arm, line up the arm hole with the arm collar hole, and pin the arm in place by pressing the pin button.



Figure 4-20 Pin Arm in Place

11. Pick an angle for the payload adaptor, line up the arm hole with adaptor hole, and pin the arm in place by pressing the pin button.

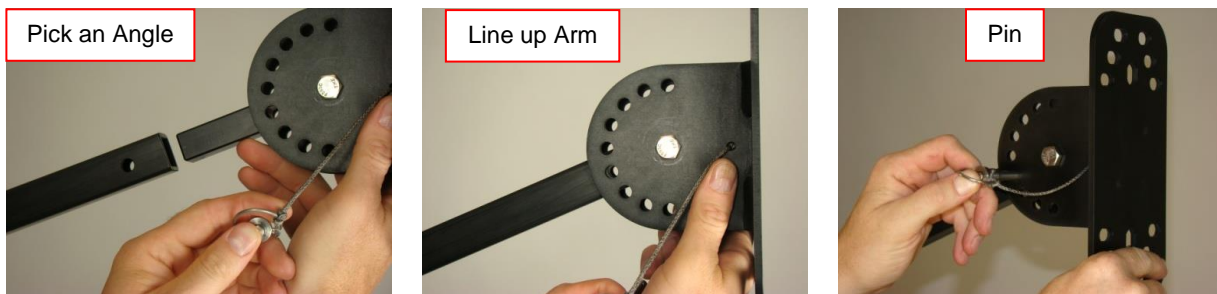

Figure 4-21 Pin Payload Adaptor in Place

12. Connect the payload to the payload adapters. The payload weights (maximum of 40 lb. / 18.1 kg) should be distributed on multiple collar arms as much as possible. The maximum allowable weight per arm is 20 lb. / 9 kg. For payload weights and wind sail areas outside website specified limits, contact The Will-Burt Company.
13. Repeat Steps 10, 11, and 12 to add additional collar arms.

Install the Accessory Guy Collar

14. Unlock the top and bottom clamps of the accessory guy collar and place the guy collar onto the top of the top tube. If a second guy collar and lines are wanted for additional support, place both collars onto the top tube. The second guy collar, if used, can be tightened onto another tube as it is loaded. The payload can be attached above the guy collar. For payload weights and wind sail areas outside website specified limits, contact The Will-Burt company.



Figure 4-22 Place Guy Collar onto Top Tube

15. If using the rigid accessory guy collar, rotate the guy collar so that the four guy lines will land on the ground where you want. For the swivel guy collar, this is not needed since the guy plate swivels into any position.
16. Lock the top and bottom clamps.

Connect to Guy Collar

17. Remove the four guy line spools from the guy bag. Connect the single-line, hook ends from the bottom, to the four holes in the 4-way guy collar (1 ¼ in / 31.8 mm or 2 in / 50.8 mm) or the accessory guy collar at 90° angles.



Figure 4-23 Connect Hook Ends to 4-Way Guy Collar

18. Let enough slack out of each guy line and place the spools on the ground about 10 ft / 3 m from the center of the tripod in the general area where the stakes will be driven. Ensure that the lines are free of obstructions and snags. If you are raising the mast during windy conditions, the mast will need to be guyed as you raise the mast.

4.6.1.2 Complete Tripod Installation

Fully Raise the Tripod Legs

19. As a team, unlock the leg clamps, step on the leg bases, and lift the tripod until the nested legs drop and are fully extended. Lock the leg clamps.



Figure 4-24 Raise Tripod Legs

Level the Tripod

20. Check the front level. If the tripod is not level, unlock one of the adjacent leg clamps and lower one of the legs. Relock the leg clamp.

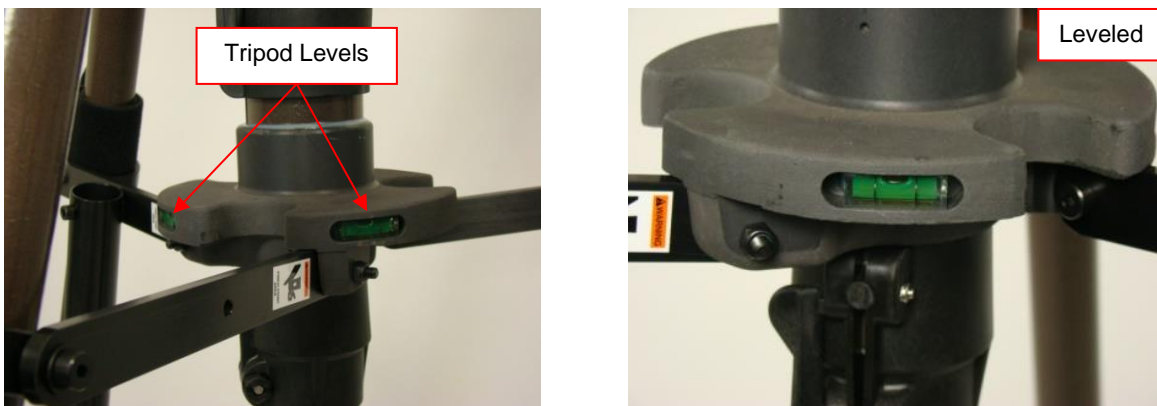

Figure 4-25 Adjust Legs as Needed and Consult Bubble Level to Ensure Tripod is Level

21. Check the side level. If the tripod is not level, unlock one of the adjacent leg clamps and lower one of the legs. Lock the leg clamp.
22. Check that all clamps on the mast are locked. There are three clamps on the legs, and two on the center of the tripod.

Stake the Tripod

⚠ WARNING

Safety Instruction! Be careful of buried cables and utilities when staking the mast.

23. Remove the stakes and hammer from the guy bag. Stake the base plates of each leg by driving a stake(s) in the two stake points aligned with the shaft of the hitch pin using the hammer. Stakes should be driven at an angle toward the center of the mast with the eyelet toward the tripod leg.

- **For masts 8 ft / 2.4 m to 40 ft / 12.2 m tall and smaller payloads:** One stake may be sufficient.
- **For masts taller than 40 ft / 12.2 m:** Two stakes are required on each tripod leg plate.



Figure 4-26 Stake the Tripod

4.6.1.3 Raise the Mast

Currently you have installed the tripod and connected the guy lines to the guy collar. Figure 4-27 shows the progress on the installation of a mast with one accessory arm. Now you will breach load the remaining tubes, which raises the mast. The last tube installed is the base tube that will have a plate at the bottom.



Figure 4-27 Installation Progress

Set Aside the Base Tube

24. So that the base tube does not get confused with the other mast tubes, it is best to place the plate on the base tube now. The base tube has the rounded plate adapter at the bottom. Locate the base tube and place a base plate on the bottom. Set this tube off to the side, it will be installed last.

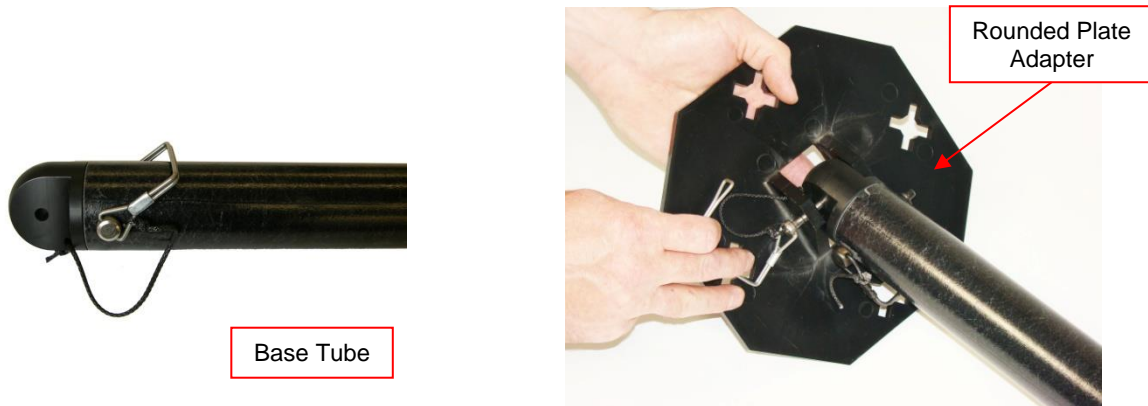
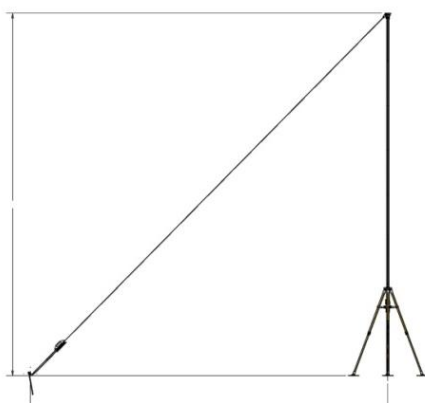

Figure 4-28 Attach Base Plate to Base Tube

Stake the Guy Lines

25. Align the guy stakes to coincide with the four holes on the guy collar on the top of the mast (not required to align for the swivel collar since it automatically adjusts to the stakes). Place the stakes 90° apart.
26. If possible, drive the stakes a distance equal to the mast height from the center of the mast.



Guy Distance = Mast Height

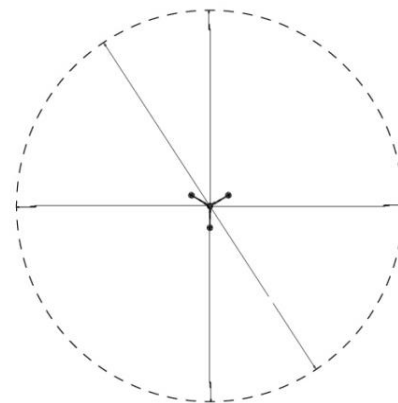

Guy Distance (x2)

Figure 4-29 Drive the Stakes a Distance Equal to the Mast Height from the Center of the Mast

27. Drive each stake, with the hammer provided, into the ground at a 45° angle away from the tripod. Ensure that the stake is driven into the ground up to the eyelet of the stake and that the eyelet is facing the tripod.



Figure 4-30 Drive Each Stake into the Ground at a 45° Angle

28. Clip the carabineer of each of the tensioners to the ring of the guy stake.

Stage the Guy Lines

29. For masts near maximum payloads and for masts 44 ft / 13.4 m to 60 ft / 18.2 m tall, prepare the guy lines for a tube to be breech loaded by loosening a maximum of 5 ft / 1.5 m of guy line from each tensioner.

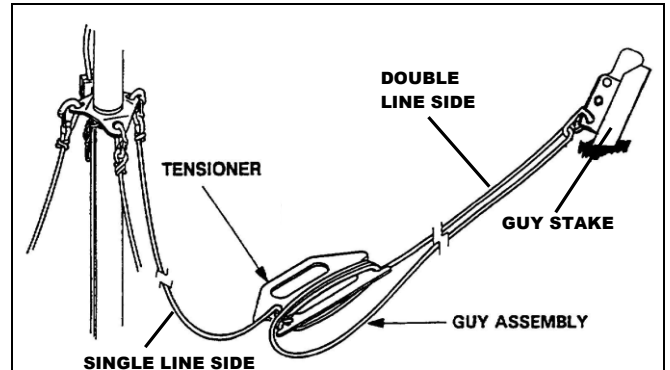
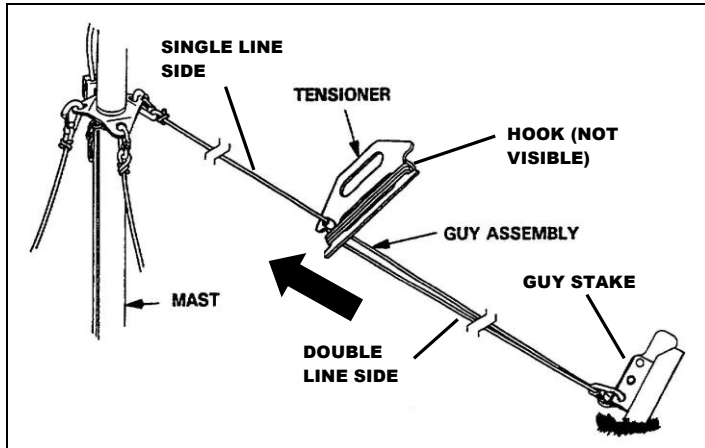

Figure 4-31 Prepare Guy Lines

Breech Load Tubes

30. Place a tube (but not the base tube) into the bottom with the white button up and in the notch in the other tube.

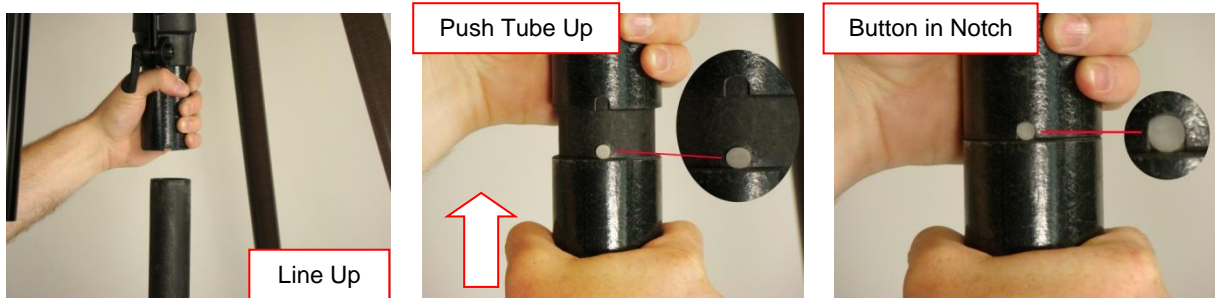

Figure 4-32 Place a Tube into the Bottom

31. While holding onto the tube just loaded, unlock the lower clamp, push the tube up until only a hand's length is visible, then lock the lower clamp. The puck can also be used to push up the tubes. Repeat Steps 30 and 31 until all tubes are breech loaded.

Install Base Tube

32. Place the base tube (tube with the base plate attached) into the bottom tube with the white button up and in the notch in the other tube. Raise the base tube until the white button seats in the notch. While holding onto the base tube, unlock the lower clamp and slowly allow the mast tubes and base tube to lower and rest level on the ground. Lock the lower clamp.

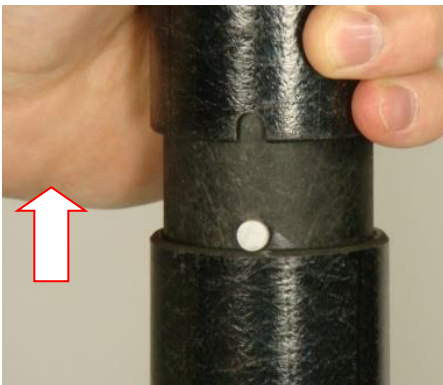

Figure 4-33 Push Up



Figure 4-34 Button in Notch



Figure 4-35 Lower to Ground

Stake the Base Plate

33. Stake the base plate of the base tube by driving the stake, with the hammer provided, at a point aligned with the shaft of the hitch pin. The stake should be driven at an angle toward the center of the mast.

- **For masts 8 ft / 2.4 m to 40 ft / 12.2 m tall and smaller payloads:** One stake may be sufficient.
- **For masts taller than 40 ft / 12.2 m:** Two stakes are required, depending on the soil type.

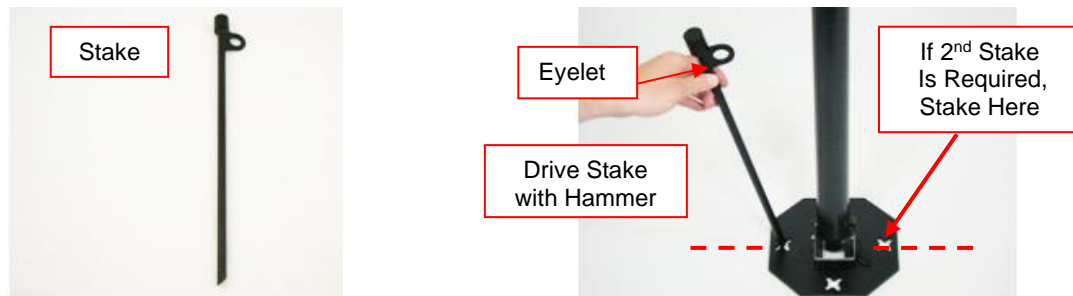

Figure 4-36 Stake the Base Plate

Tighten the Guy Lines

Note: When tightening the guy lines, do not over-tighten the guy lines. Tighten the lines to the point that the mast is stabilized, sway is minimized, and the mast is stable during winds. Over-tightening the guy wires causes an additional or unlevel load on the mast and reduces the overall load capacity of the mast.

34. Ensure that guy line attached to the stake coincides with the aligned hole in guy collar on top the mast.
35. Ensure that none of the guy lines are crossed.
36. Tension the lines by sliding the tensioner toward the mast and lock it into position by placing the tensioner hook over the double guy line.

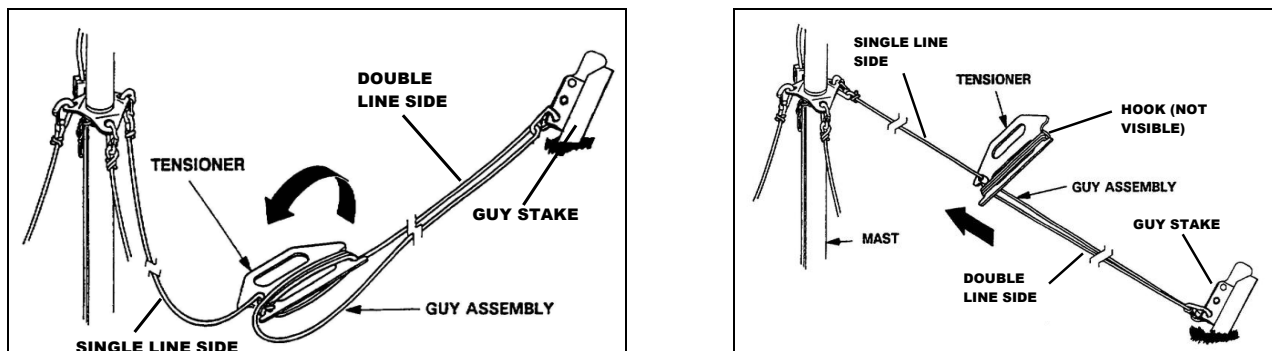

Figure 4-37 Tighten Guy Lines

37. Check that the center mast tube remains straight and perpendicular.

4.6.2 Deployment with EZ Raze™ Option

Note: If installing the mast at maximum load (40 lb. / 18.1 kg total, 20 lb. / 9 kg per arm), three people are required. This allows enough people to raise the payload and to steady the payload arms as the mast is being guyed.

To deploy the mast with the EZ Raze™ option:

4.6.2.1 Install the Top of the Mast

Insert the Top Tube

1. Stand in the operator's quadrant. This area is next to the winch holder and in front of one of the levels. Lock the upper clamp. See Section 7.5 to check that the clamp is sufficiently tight. Unlock the lower clamp.

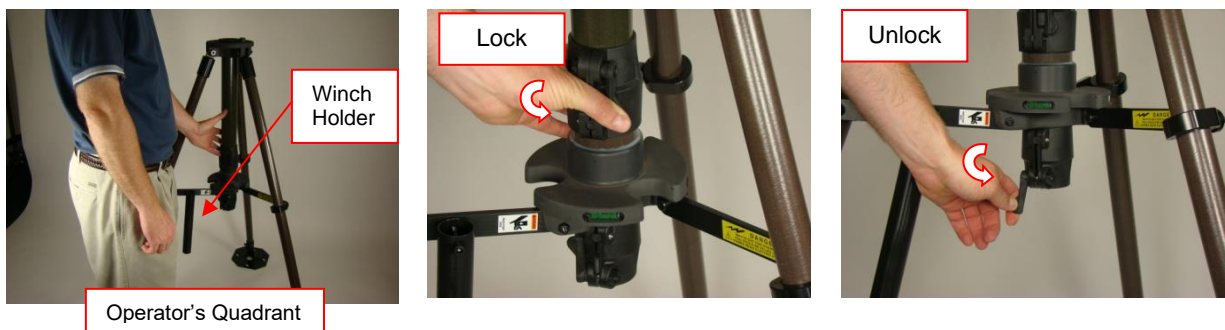

Figure 4-38 Lock the Upper Clamp and Unlock the Lower Clamp

2. Retrieve a tube from the tube bag. This will be used as the top tube. Insert the top tube from the top of tripod. Ensure that the white knob, upper clamp, and lower clamp are in a straight line.

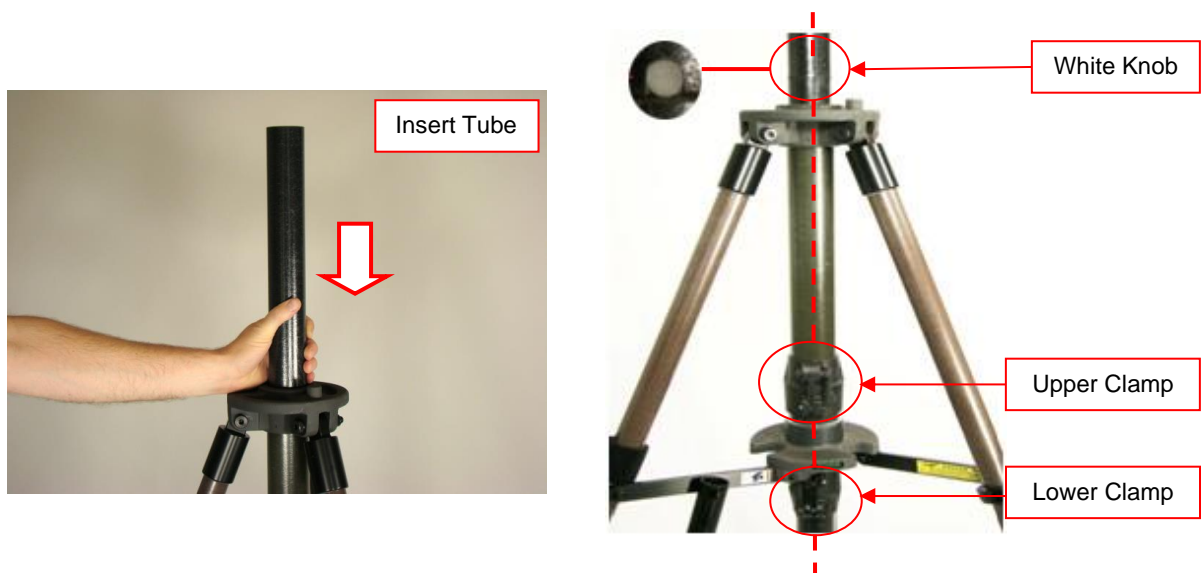

Figure 4-39 Insert Top Tube from the Top of the Tripod

3. Lower the top tube until there is one hand width from the bottom of the tube and lock the lower clamp. See Section 7.5 to check that the clamps are sufficiently tight.

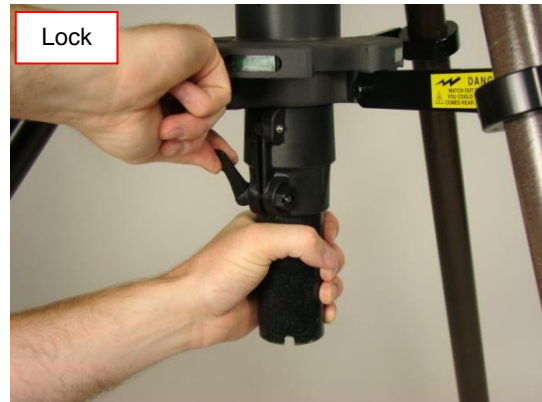

Figure 4-40 Lower Top Tube until There is One Hand Width from the Bottom of the Tube and Lock the Lower Clamp

Install Carriage

4. After the tripod and the top tube have been installed, slide the carriage assembly onto the top tube. Ensure that the pigtails are in the front and the eyelet is up and in the back.

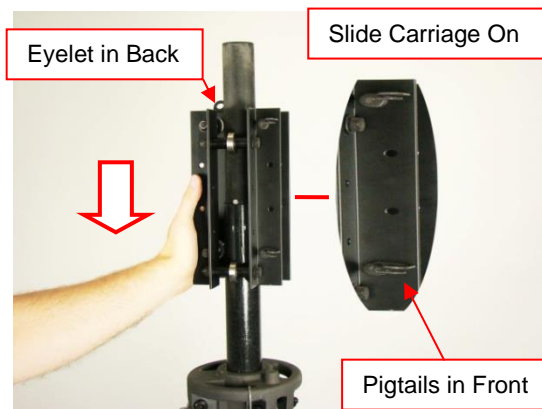
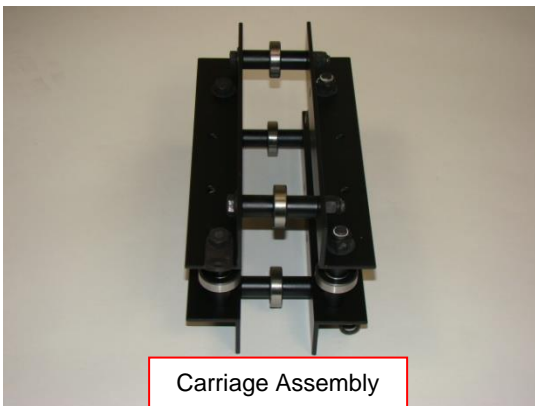

Figure 4-41 Slide Carriage Assembly onto the Top Tube

Install Tip Tube

- Retrieve the tip tube from the tube bag. The tip tube is the tube has an integrated pulley and guy collar. Insert the tip tube from the top of the tripod with the white button in the notch of the top tube. Ensure that the white knob, upper clamp, and lower clamp are in a straight line.



Figure 4-42 Tip Tube



Figure 4-43 Insert Tip Tube

- Ensure that the assembly eyelet is on the backside of the mast. Ensure that the tripod platform stub goes between the edges of the carriage.

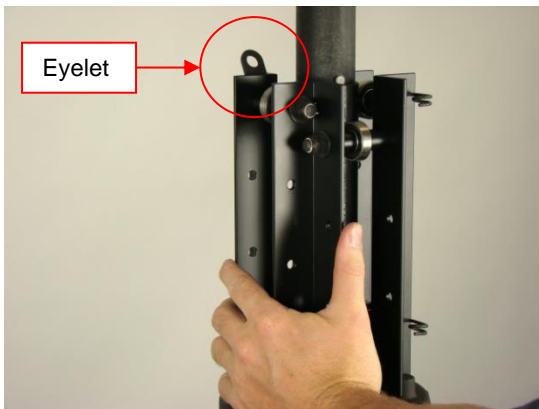

Figure 4-44 Ensure the Eyelet is on the Backside of the Mast

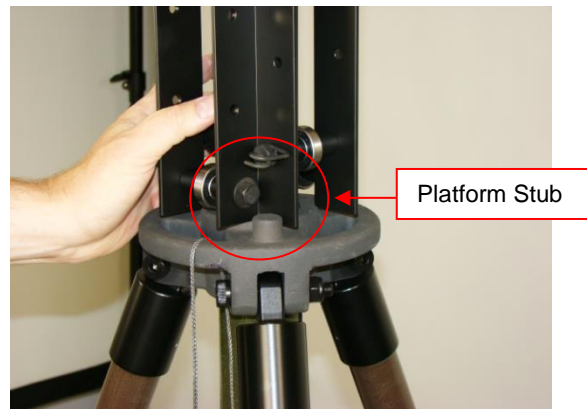

Figure 4-45 Ensure the Platform Stub Goes Between the Edges of the Carriage

Install the Carriage Arms

- Remove the two side brackets from the small bag. There are two long pins and two short pins on each bracket. Put the brackets on the inside of the carriage and secure with the two long pins from the back of the bracket so the pin loops will not snag on the cable that is installed later.

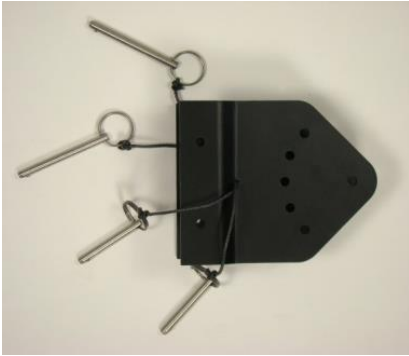

Figure 4-46 Side Bracket

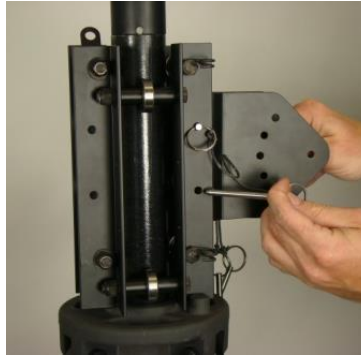

Figure 4-47 Back View

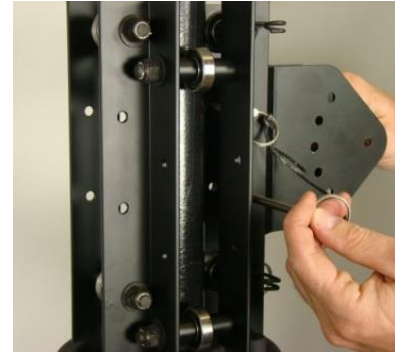

Figure 4-48 Insert Long Pins

- Connect the arm to the bracket with the front small pin. Ensure that the coax loops are facing down. Also ensure that the 8 holes are at the end of the arm. This will prevent you from pinning the extension when you pin the arm to the carriage. Pick an angle for the extension arm and pin into one of the directional holes with the rear small pin.

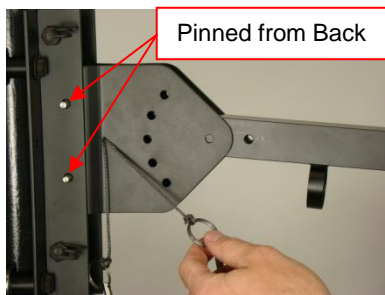

Figure 4-49 Pick an Angle for the Extension Arm and Pin into Place

- If additional length is required, pull out the extension inside the arm and pin it.



Figure 4-50 Arm Not Extended

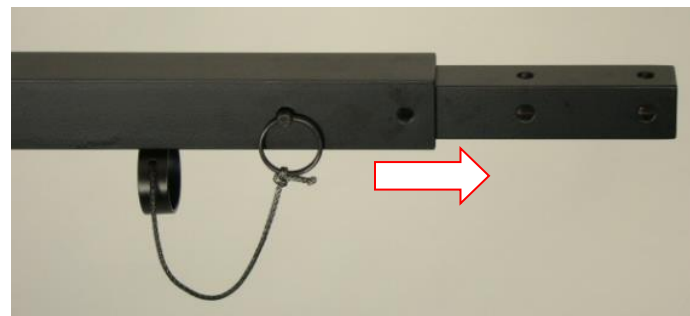

Figure 4-51 If Required, Extend and Pin

10. If a cup holder is required, on the end of the extension arm, connect the cup holder to the carriage with one front pin. Ensure that the top of the cup holder is open (bottom is closed). Determine the angle of the extension arm and pin using one of the directional holes. Connect the payload to the cup holder. For payload weights and wind sail areas outside website specified limits, contact The Will-Burt Company.

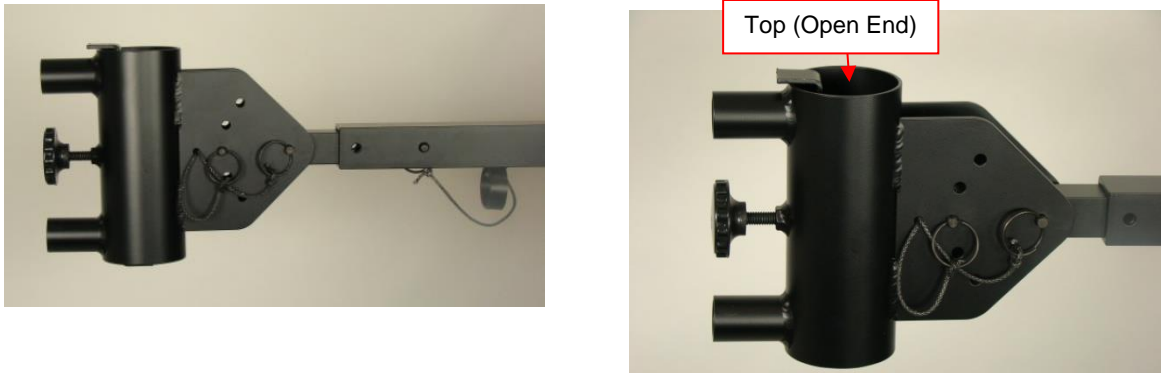

Figure 4-52 Cup Holder

11. If a bolster plate is required, on the end of the extension arm, connect the bolster plate to the carriage with one front pin. The bolster plate can be connected vertical or horizontal. Determine the angle of the extension arm and pin using one of the directional holes. Connect the payload to the bolster plate. For payload weights and wind sail areas outside website specified limits, contact The Will-Burt Company.



Figure 4-53 Connect the Bolster Plate to the Carriage

Connect the Carriage

12. Take more slack from the winch cable to allow for feeding the cable through the tip tube.
13. Connect the cable to the carriage by pushing the snap hook on the winch cable through the hole in the tripod collar. Feed the cable through the pigtails of the carriage. Then feed the snap hook through the top tube.

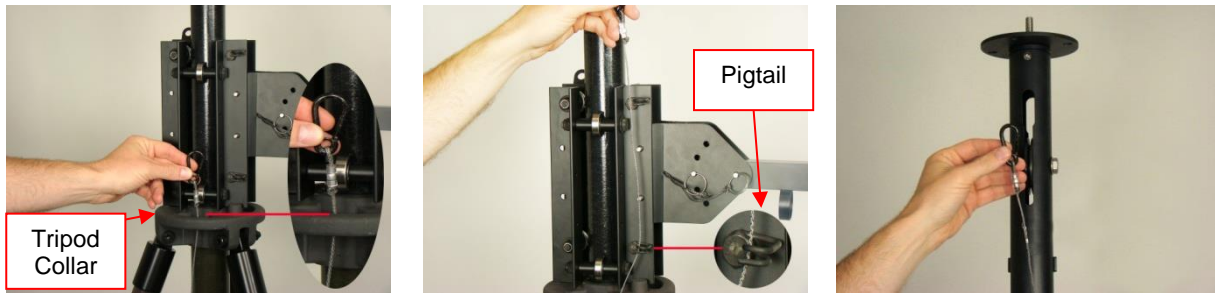

Figure 4-54 Connect Cable to the Carriage

14. Feed the snap hook through the top pulley and down to the carriage eyelet and snap into place.



Figure 4-55 Feed Through Pulley

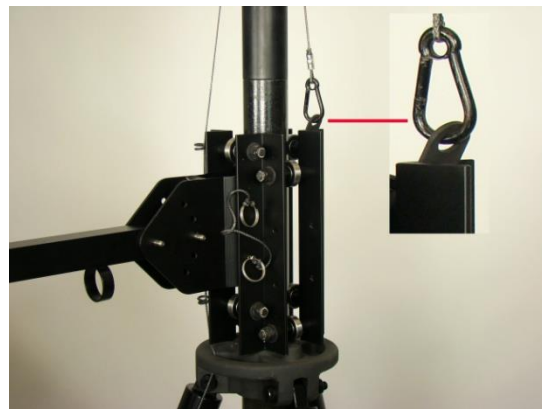

Figure 4-56 Connect to Eyelet

Connect to Guy Collar

15. Remove the four guy line spools from the guy bag. Connect the single-line, hook ends from the bottom, to the four larger, guy plate holes at 90° angles.



Figure 4-57 Guy Lines



Figure 4-58 Hook to Guy Plate



Figure 4-59 Single Line to Collar

16. Let enough slack out of each guy line and place the spools on the ground about 10 ft / 3 m from the center of the tripod in the general area where the stakes will be driven. Ensure that the lines are free of obstructions and snags. Check that the guy lines will not hit the payload as it is raised. If you are raising the mast during windy conditions, the mast will need to be guyed as you raise the mast.

4.6.2.2 Complete Tripod Installation

Fully Raise the Tripod Legs

38. As a team, unlock the leg clamps, step on the leg bases, and lift the tripod until the nested legs drop and are fully extended. Lock the leg clamps.



Figure 4-60 Raise Tripod Legs

Level the Tripod

39. Check the front level. If the tripod is not level, unlock one of the adjacent leg clamps and lower one of the legs. Relock the leg clamp.

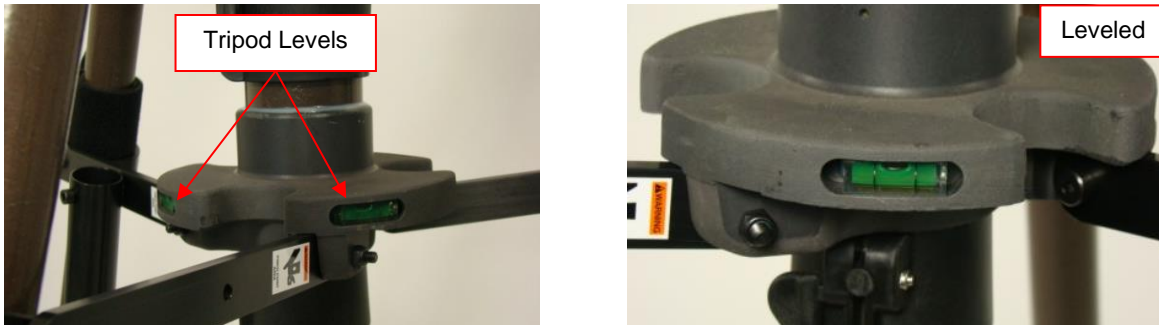

Figure 4-61 Adjust Legs as Needed and Consult Bubble Level to Ensure Tripod is Level

40. Check the side level. If the tripod is not level, unlock one of the adjacent leg clamps and lower one of the legs. Lock the leg clamp.
41. Check that all clamps on the mast are locked. There are three clamps on the legs, and two on the center of the tripod.

Stake the Tripod



Safety Instruction! Be careful of buried cables and utilities when staking the mast.

42. Remove the stakes and hammer from the guy bag. Stake the base plates of each leg by driving a stake(s) in the two stake points aligned with the shaft of the hitch pin using the hammer. Stakes should be driven at an angle toward the center of the mast with the eyelet toward the tripod leg.
- **For masts 8 ft / 2.4 m to 40 ft / 12.2 m tall and smaller payloads:** One stake may be sufficient.
 - **For masts taller than 40 ft / 12.2 m:** Two stakes are required on each tripod leg plate.



Figure 4-62 Stake the Tripod

4.6.2.3 Raise the Mast

Set Aside the Winch Tube

17. So that the winch tube does not get confused with the other mast tubes, it is best to place the plate on the winch tube now. The winch tube has the rounded plate adapter at the bottom. Locate the winch and place a base plate on the bottom. Set this tube off to the side, it will be installed last.

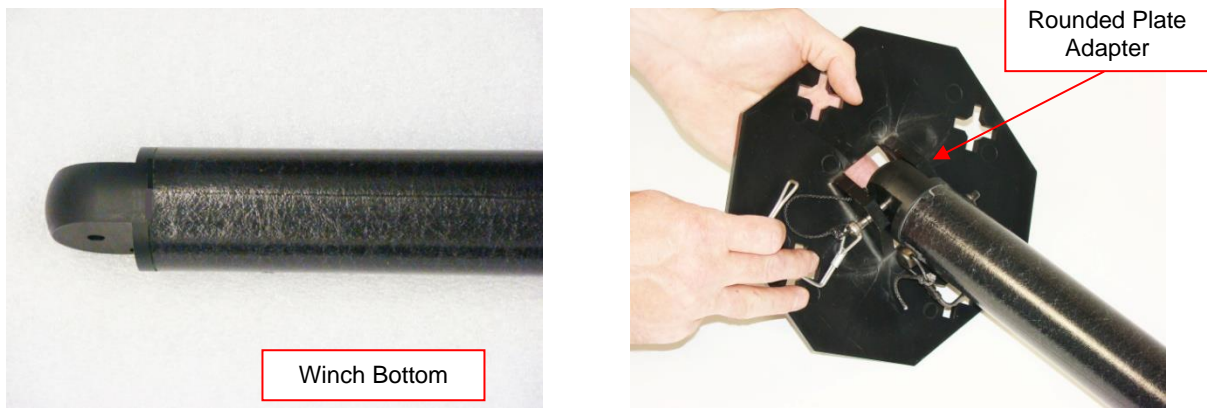
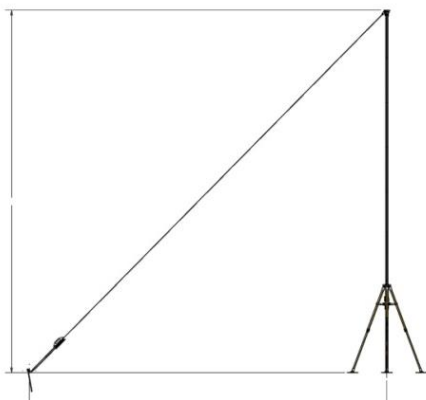

Figure 4-63 Attach Base Plate to Winch Tube

Stake the Guy Lines

43. Align the guy stakes to coincide with the four holes on the guy collar on the top of the mast (not required to align for the swivel collar since it automatically adjusts to the stakes). Place the stakes 90° apart.
44. If possible, drive the stakes a distance equal to the mast height from the center of the mast.



Guy Distance = Mast Height

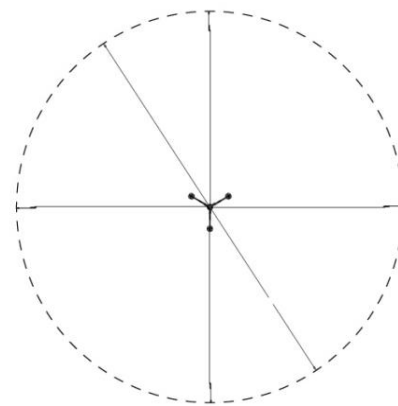

Guy Distance (x2)

Figure 4-64 Drive the Stakes a Distance Equal to the Mast Height from the Center of the Mast

45. Drive each stake into the ground at a 45° angle away from the tripod. Ensure that the stake is driven into the ground up to the eyelet of the stake and that the eyelet is facing the tripod. Clip the carabineer of each of the tensioners to the ring of the guy stake.



Figure 4-65 Drive Each Stake into the Ground at a 45° Angle

Place the Winch in the Retainer

18. Unlock the winch spool by pulling the J-hook and resting on top the winch assembly.

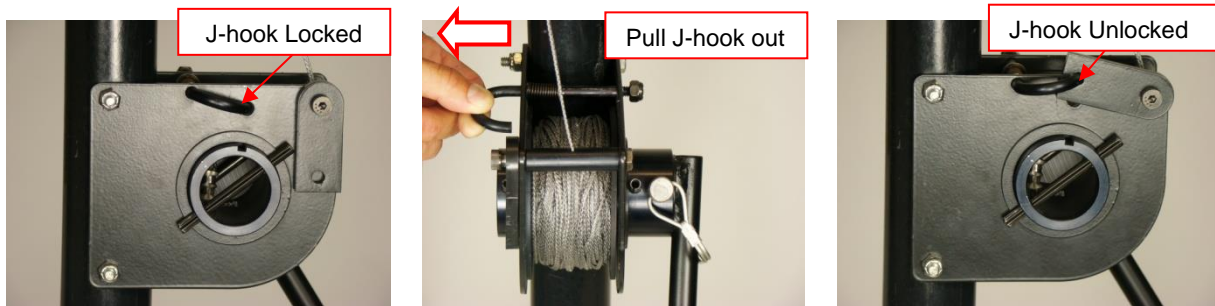

Figure 4-66 Unlock Winch Spool

19. Use the hitch pin to attach the handle to the winch. Place the top of the winch into the bottom of the winch holder.

- **For 1 ¼ in / 31.8 mm tubes:** The winch tube will go inside the holder.
- **For 2 in / 50.8 mm tubes:** The winch tube will go outside the holder.

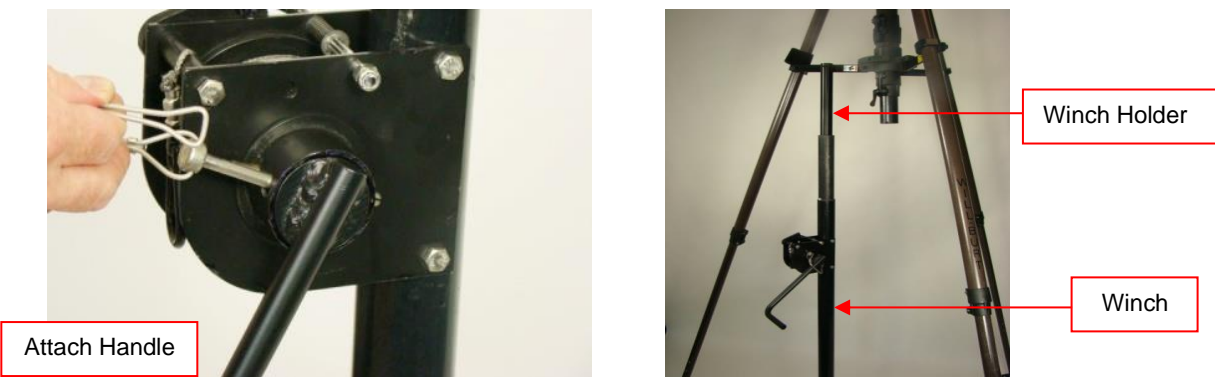

Figure 4-67 Use the Hitch Pin to Attach the Handle to the Winch

Stage the Guy Lines

20. For masts 44 ft / 13.4 m to 60 ft / 18.3 m tall, prepare the guy lines for a tube to be breech loaded by loosening a maximum of 5 ft / 1.5 m of guy line from each tensioner.

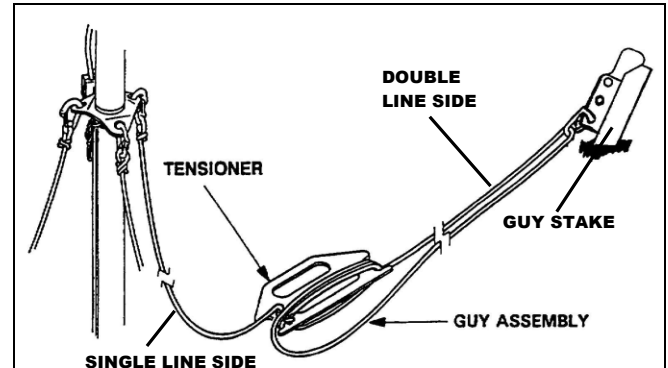
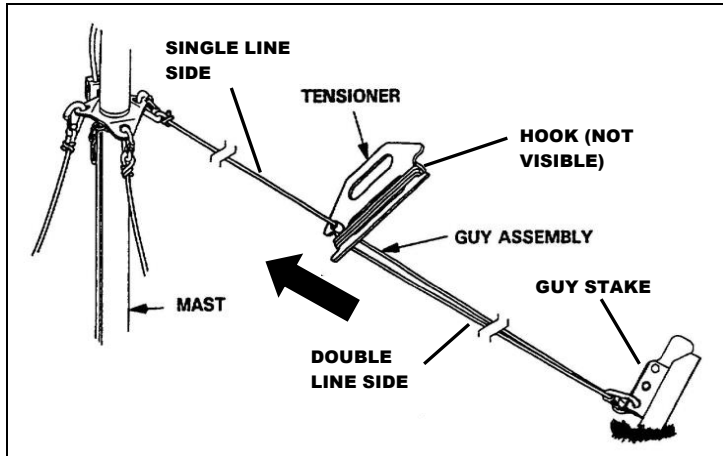

Figure 4-68 Prepare Guy Lines

Add Slack to Winch Cable

21. Since the cable pulley is attached to the tip tube, the cable must be adjusted before each tube is breech loaded. Before loading a tube, add slack to the cable line by turning the winch handle clockwise. This allows the pulley to be raised when the tubes are breech loaded. Ensure that the winch line is free of obstructions and snags.



Figure 4-69 Cable Path Shown in Red



Figure 4-70 Add Slack to Cable

Breech Load Tubes

22. Place a tube into the bottom with white button up and aligned with the notch in the other tube.



Figure 4-71 Line Up

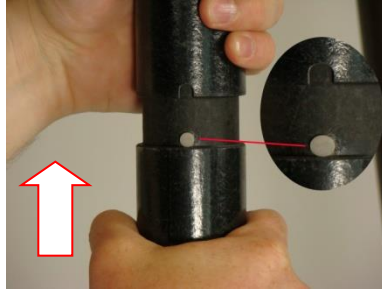

Figure 4-72 Push Tube Up

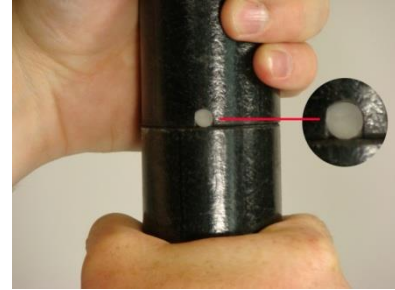

Figure 4-73 Button in Notch

23. While holding onto the tube just loaded, unlock the lower clamp, push the tube up until only a hand's length is visible, then lock the lower clamp. Repeat Steps 20, 21, 22 and 23 until all tubes are breech loaded.

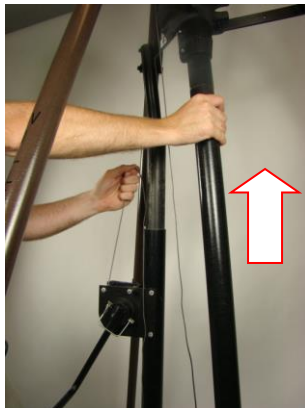

Figure 4-74 Push Tube Up

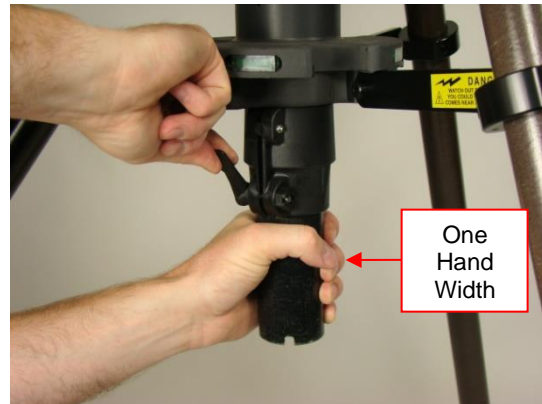

Figure 4-75 Lock Lower Clamp

Install Winch as Base Tube

24. Once the desired height is reached, remove the winch from the winch holder. Insert the winch tube into the bottom tube with the white button up and in the notch of the other tube. Ensure that the pulley and the white button are properly aligned.
25. While holding onto the winch base tube, unlock the lower clamp and slowly allow the winch tube to lower and rest on the ground. Lock the lower clamp.
26. Pull the J-hook and place it through the locking hole in the winch. If it does not seat, turn the winch handle counterclockwise until the J-hook seats through the locking hole and a spool hole in the winch. This will safely lock your payload.

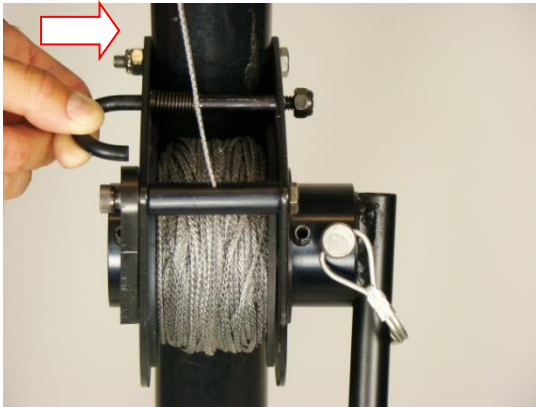

Figure 4-76 Lock J-hook

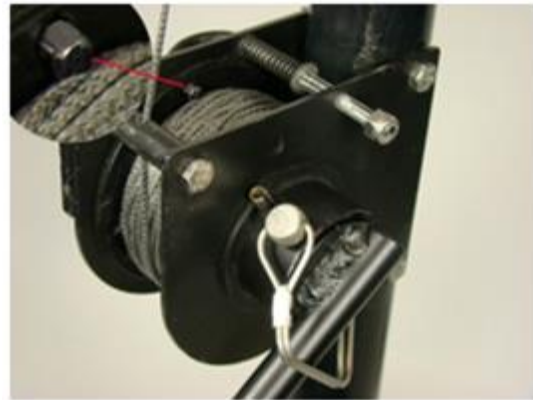

Figure 4-77 J-hook Locked

Stake the Winch Base Plate

27. Stake the base plate of the winch base tube by driving a stake in one of the two stake points aligned with the shaft of the hitch pin using the provided hammer. Stakes should be driven at an angle toward the center of the mast.
 - **For masts 8 ft / 2.4 m to 40 ft / 12.2 m tall and smaller payloads:** One stake may be sufficient.
 - **For masts taller than 40 ft / 12.2 m:** Two stakes are required, depending on the soil type.

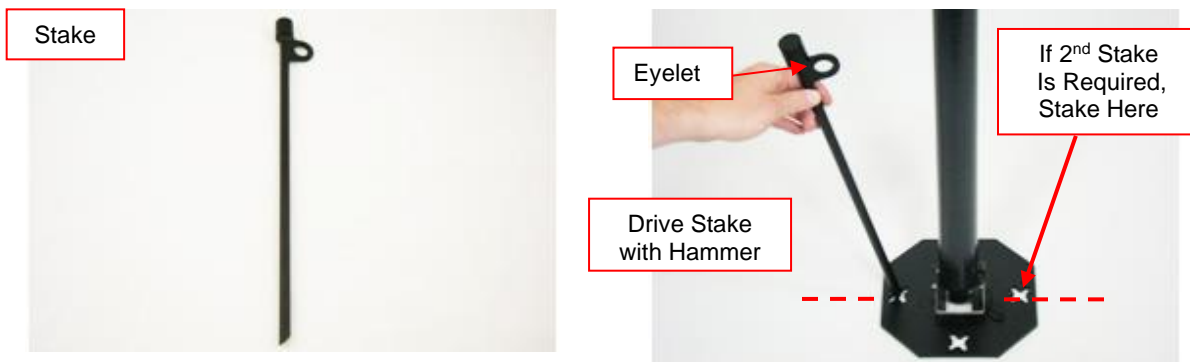

Figure 4-78 Stake the Base Plate

Tighten the Guy Lines

Note: When tightening the guy lines, do not over-tighten the guy lines. Tighten the lines to the point that the mast is stabilized, sway is minimized, and the mast is stable during winds. Over-tightening the guy wires causes an additional or unlevel load on the mast and reduces the overall load capacity of the mast.

28. Ensure that guy line attached to the stake coincides with the aligned hole in guy collar on top the mast.
29. Ensure that none of the guy lines are crossed.
30. Tension the lines by sliding the tensioner toward the mast and lock it into position by placing the tensioner hook over the double guy line.

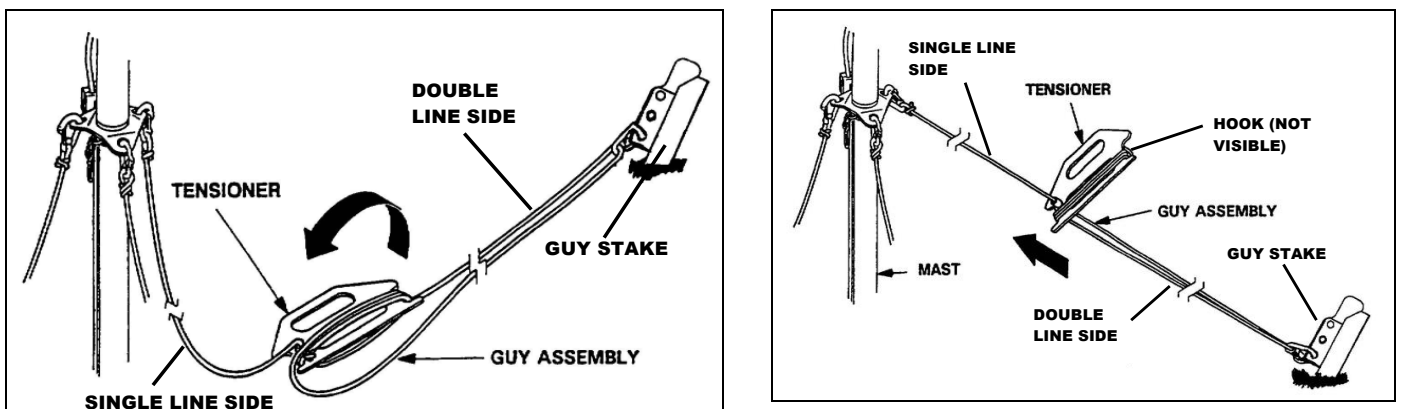

Figure 4-79 Tighten Guy Lines

31. Check that the center mast tube remains straight and perpendicular.

4.6.2.4 Raise the Payload

Connect the Step

32. Use the hitch pin to attach the step to the tripod. The step allows easier access to the payload.

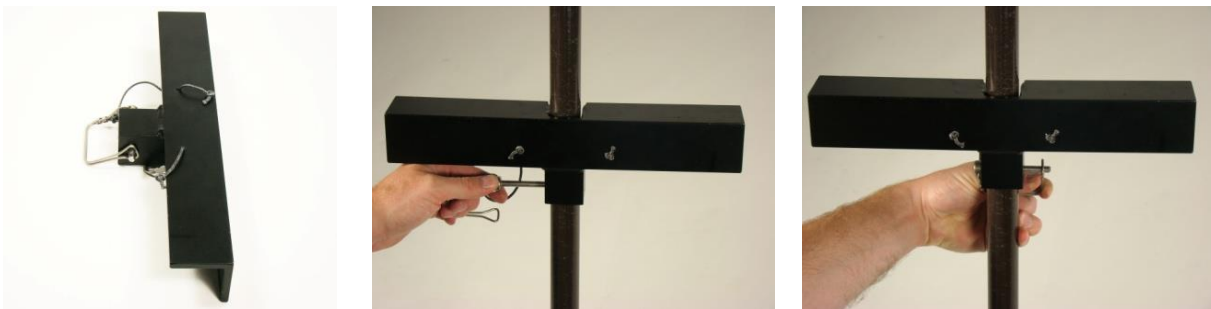

Figure 4-80 Use the Hitch Pin to Attach the Step to the Tripod

Unlock the Winch Spool

⚠ WARNING

Safety Instruction! There is no brake on the EZ Raze™ Option. Ensure that the safety latch is properly functioning to ensure that when the payload is raised, it cannot fall freely. If the winch cable ever breaks, quickly get away from the tripod because the payload will drop freely.

33. Pull on the J-hook to unlock the safety latch and spool. Turn the safety latch downward. Ensure that the safety latch moves freely.



Figure 4-81 Unlock Winch Spool

Turn Winch to Raise the Payload

34. Turn the winch handle counterclockwise to raise the payload. Ensure that the carriage slides smoothly up the shaft of the mast. The mast may bend slightly on the initial lift but should straighten out quickly. If the mast bends but does not straighten out, the payload is too heavy. See the specification sheets to ensure you have not overloaded the mast. For payload weights and wind sail areas outside website specified limits, contact The Will-Burt company. The payload is fully raised when the carriage roller engages the spade causing the payload to slightly pivot.



Figure 4-82 Turn the Winch Handle Counterclockwise to Raise the Payload

Section 5 Disassembly

This section provides instructions for disassembling the mast system and provides the general procedures that must be followed to ensure a successful disassembly. Be sure to read and understand the entire installation procedure and the Safety Summary (Section 1) before beginning disassembly.

5.1 Disassemble the Mast

To disassemble the mast, proceed as follows:

1. Slightly loosen the guy ropes to relieve any tension or binding that may exist between the mast tubes.
2. After making certain that the lock of the lower clamps is unlocked, lift up on the base tube enough to allow it to be removed. Lock the lower clamp of the tripod onto the next tube of the mast. Remove the base tube.
3. While holding the exposed portion of the tube (locked by the lower clamp), unlock the lower clamp and ease the tube down to where the tube is free from the lower clamp. Allow the next tube to slowly lower until it enters the lower clamp and a hand width of tube is exposed. Lock the lower clamp and remove the free tube from under the tripod.
4. If accessories are installed on the tube, disassemble the accessories and place into the appropriate bags.
5. Repeat Steps 3 and 4 for the remaining tubes until all the tubes have been removed (except for the top tube). Place the tubes into the tube bag.
6. Remove the guy stakes from the tripod base plate and place them into the guy bag.
7. Unlock the tripod legs and allow the legs to retract within themselves, bringing the mast to a comfortable working height.
8. Detach the guy line hooks from the guy collar on the top tube.
9. Detach the guy line hooks from the stakes. Wind the guy line around the tensioner. Remove the stakes. Place the guy lines and stakes into the guy bag.
10. Remove the 4-way guy collar or the accessory guy collar from the top tube and place the guy collar and top tube into appropriate bags.
11. Unlock the upper clamp on the transport and fold up the tripod.
12. Remove the base plates from the tripod. Place the tripod and base plates into wheeled bag.
13. Store all bags and components into the wheeled bag.

5.2 Disassemble the Mast with EZ Raze™ Option

To disassemble the mast with the EZ Raze™ option, proceed as follows:

1. Unlock the winch, lower payload, and remove the devices from the mast.
2. Slightly loosen the guy ropes to relieve any tension or binding that may exist between the mast tubes.
3. Loosen the lever on the lower clamp. Remove the base pole by lifting slightly on the base pole. Tighten the clamp lever so that the next pole remains in place. Place the base pole (with winch) into the winch holder.

 **WARNING**

Safety Instruction! Do not allow poles to separate above the lower collar. This will cause the mast to become unstable.

4. Remove the next mast section using the same process. Once the mast section has been removed, take up the slack from the cable using the winch on the base pole. Leave enough slack in the cable to allow for the easy removal of the next mast section.
5. Repeat the above process for the remaining mast sections until all of the mast sections have been removed. Note: Do not remove the last tube until the tip and carriage are removed. Store the mast sections into the tube bag.
6. Detach the snap hook on the winch cable from the carriage assembly and wind up the remaining cable. Remove the base pole (with winch) and store it into the appropriate bag.
7. Detach the guy ropes from the guy stakes and top pulley and wind them on to the rope stay. Remove the guy stakes and store them and the guy ropes into the guy bag.
8. Remove the top pulley and the carriage assembly. Make sure all of the pins are properly stored on the side plates and attachments. Place into the short bag.
9. Remove the guy stakes from the tripod and store them into the guy bag.
10. Collapse the tripod and allow the nested legs to telescope into the tripod legs. Fold the tripod and tighten all clamps on the tripod legs. You may find it easier and quicker to store the tripod with the base plates attached. Store the tripod in the wheeled bag.
11. Store all bags and components into the wheeled bag.

Section 6 Transportation

Before transporting the mast system, the mast system needs to be secured. The exact procedures for transportation will vary based on the mast system configuration. The process described in this manual represents a possible method of transporting the mast. Depending on the environment and equipment available, other methods may work better. Use the best and safest method for your circumstances.

6.1 General Transportation

To prepare the mast system for transportation:

1. Ensure the mast and components are fully and properly disassembled and placed into the appropriate storage bags such as the wheeled bag and accessories bag (Section 5). Do not transport the mast system with the mast and payload extended. Always visually confirm the mast is fully disassembled before moving the mast.
2. If possible, secure the payload.
3. If necessary, secure the optional EZ Raze™.
4. If necessary, secure any additional components in the mast system.

Note: The operator should always visually confirm the mast is entirely disassembled and properly stored before moving the mast for transport.

6.2 Shipping

When shipping the mast system, The Will-Burt Company recommends shipping the mast in the original shipping container shrink-wrapped to a pallet. If the original shipping container is not available, contact The Will-Burt Company to order a replacement.

When shipping:

1. Prepare the mast system for transportation (Section 6.1).
2. Secure the mast system in the shipping container and shrink-wrap the shipping container to the pallet:
 - a. Carefully position the mast and additional components in the shipping container.
 - b. Secure the lid on the shipping container.
 - c. Shrink-wrap the shipping container to the pallet.

(This page is intentionally left blank.)

Section 7 Maintenance

This section describes maintenance procedures required to keep the mast system operational. Use care to understand and follow all precautions while performing these procedures. If the system does not perform as required, contact The Will-Burt Company.

Disconnect power to any devices mounted to the mast with lock-out tagout procedures as appropriate before performing mast maintenance.

7.1 Pre-Maintenance Check

Before performing maintenance procedures, ensure:

- All operators read and understand the entire maintenance procedure and are properly trained.
- The payload is removed prior to performing maintenance on the system.
- The system is level and secure.

7.2 Maintenance Equipment

Table 7-1 lists recommended equipment for maintenance.

Table 7-1 Equipment Recommended for Maintenance

Tools and Materials*			
Personal Protective			
Safety Glasses	Safety Gloves	Safety Shoes	Nitrile or Vinyl Gloves
Hard Hat or Helmet	Hearing Protection		
Hand Tools			
Hammer	Hex Wrenches	Plumb Bob	Measuring Tape
Level	Screwdrivers	Sockets	Wrenches
Torque Wrench	Utility Knife		
Expendables			
Non-Abrasive Cleaners (Soap and Water)	Rags (Clean and Dry)		
* Note:			
<ul style="list-style-type: none"> • Depending on the local, regional, and national standards and codes of practice, and the environment, additional personal protective equipment may be necessary. • When disposing of any disposables or components, do so according to any applicable local, regional, and national standards and codes of practice. 			

7.3 Spare Parts

To order spare or replacement parts, always refer to the mast model number and serial number. This information is included in the operator's manual supplied with each mast. The mast serial number is stamped at the bottom of the base tube. Model number, serial number and additional information is also engraved on the mast identification plate(s). The plate(s) are fixed to the base tube's collar.

To replace the white pins on the tubes and the levers on the clamps, the following two kits are available:

- Indicator Pin Replacement Kit (P/N 4592101)
- Friction Lock Lever Kit (P/N 4494901)

7.4 Periodic Maintenance

This section describes the systematic care and inspection of equipment to keep it in safe operating condition and to prevent breakdowns. If the system does not perform as required or if anything looks wrong and cannot be diagnosed and/or fixed, contact The Will-Burt Company. Table 7-1 provides a schedule of periodic inspections and procedures required to keep the mast system in safe operating condition.

Figure 7-1 Periodic Inspections

Frequency	Inspection	Action
As Needed; In salt water or sandy environments clean the mast every 3 months.	Inspect to ensure the mast system is kept clean and free from foreign material. Dirt, grease, oil, sand and debris may cover up a serious problem.	Wipe down all parts using a non-abrasive cleaner or non-acid solvent and a cloth.
During Operation	Inspect for damage during operation.	If damage is apparent, do not use the mast, and have it serviced prior to use.
Monthly	Inspect all hardware to ensure nuts, bolts, and other fasteners are not damaged, loosening, backing out or missing. Take special note of hardware keeping the payload mounted and hardware used to mount the mast to the support structure.	Tighten or replace any loose, damaged or missing nuts, bolts, and other fasteners.
Monthly	Inspect all clamps to ensure clamps are not damaged, cracked, have uneven wear or are missing.	Replace any cracked, unevenly worn, damaged or missing clamps.

Monthly	Inspect the tripod for uneven wear.	Replace unevenly worn-out component or tripod. Contact The Will-Burt Company.
As every use	Inspect all clamps for tightness when locked.	Tighten clamps if lose. Follow Section 7.5 for correct procedure.
As every use	Inspect guy lines for frayed, damaged or cut lines.	Stop use and replace frayed, damaged, or cut guy lines.
As every use	Inspect base plates for tears.	Stop use and replace damaged, base plates.
If using EZ Raze™ Option: As Every Use	Inspect EZ Raze™ cord for fraying or damage.	Stop use and replace frayed or damaged EZ Raze™ cord.

7.5 Checking and Adjusting Clamp Tightness

To check and adjust the tightness of the clamps:

1. The tube clamps hold the weight of the mast and payload. It is very important that the clamps are sufficiently tight. This section describes the steps to follow to ensure that the clamps are sufficiently tight and how to tighten if necessary.
2. Before checking for proper tightness, load a mast tube of the same outer diameter into the clamp.
3. Lock the clamp and ensure that the lever locks onto the locking tab. Check that the screw head is fully nested in the back of the hexagon hole of the clamp lever. Ensure that there are no visible gaps between the clamp housing and nut.

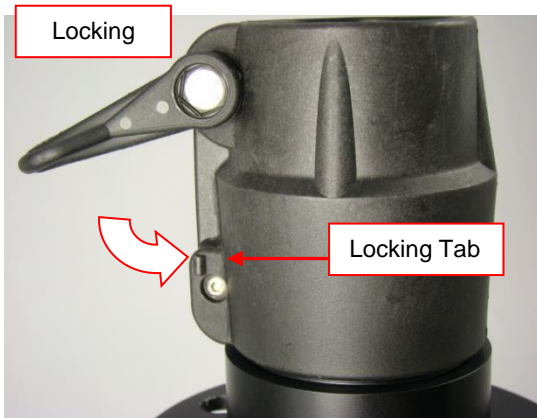

Figure 7-2 Lock the Clamp

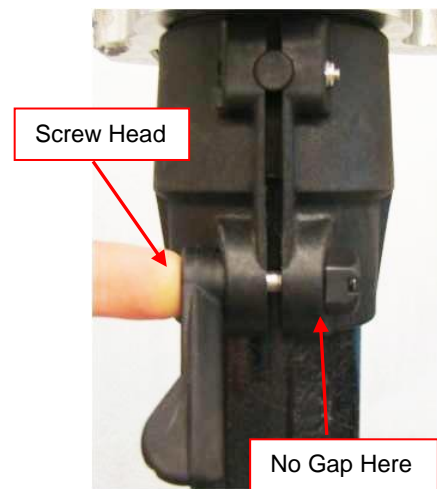

Figure 7-3 No Gaps Between the Clamp Housing and Nut

4. To ensure that the clamp is tight, by hand, turn the nut in the “+” direction shown on the nut. The clamp is tight when the nut cannot be tightened further by hand. Do not use tools to tighten. Oscillate the lever to ensure tightness. The correct tightness should have minimum movement from side to side. Do not rely on the notch of the nut to mark the fully tight orientation of the clamp.



Figure 7-4 Turn the Nut by Hand in the “+” Direction Shown on the Nut to Ensure the Clamp is Tight

5. Occasionally, unlocking and locking a clamp causes the screw head to better seat in the clamp. Unlock the clamp then repeat Steps 3 and 4 to lock and check for proper tightness.

7.6 Long-Term Storage

When putting the system into long-term storage, ensure the:

- Mast and components are fully disassembled and are placed into the appropriate bags.
- Mast and components are stored in a clean and dry environment.

7.7 System Disposal

Dispose of the mast in accordance with the national environmental regulations.