

4

3

2

1

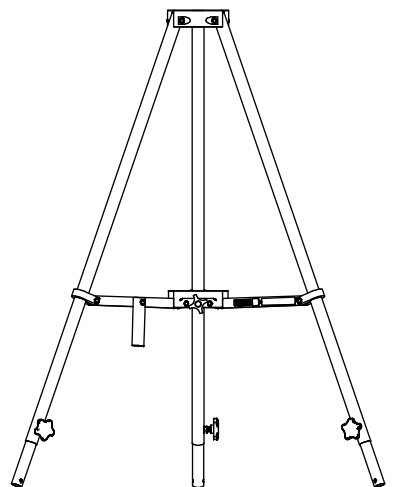

TRIPOD
P/N:4110701

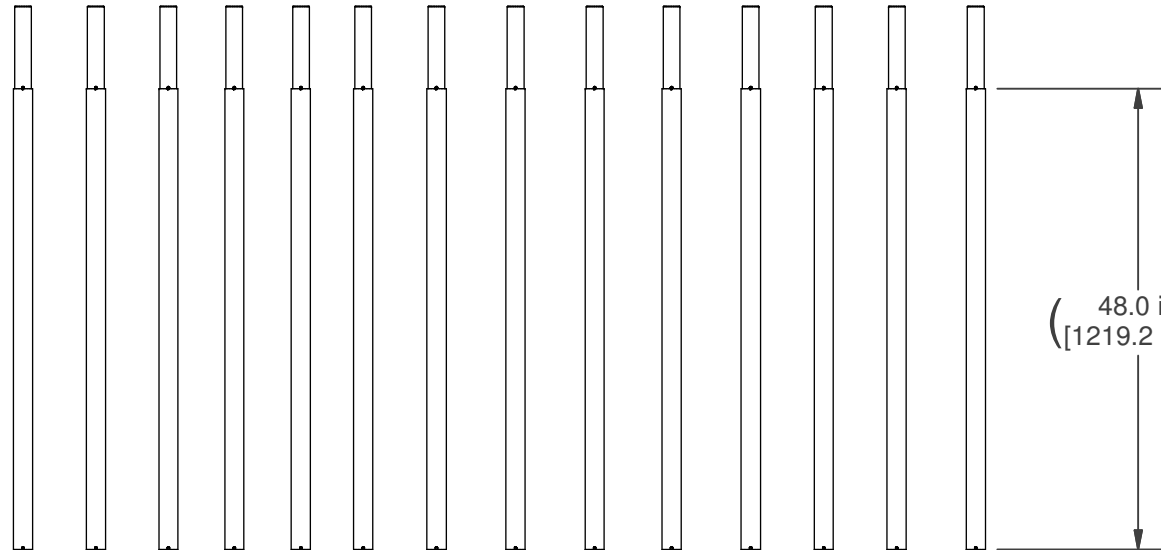

QT'Y. (14) TUBE SECTION
P/N: 4112201

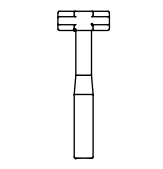

HAMMER
P/N: 4128101

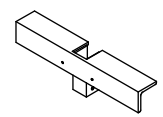

STEP
P/N: 4132101

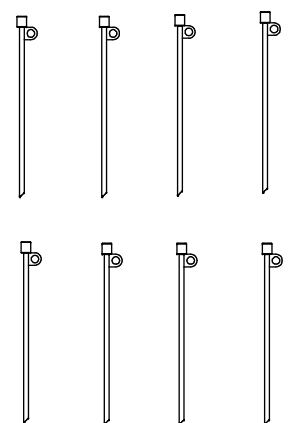

QT'Y. (8) GUY STAKE
P/N:4109901

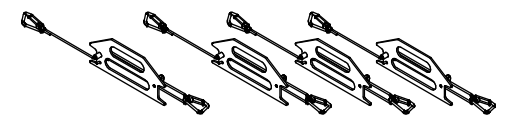

QT'Y. (4) ROPE STAY
P/N: 4383101



QT'Y. (3) BASE PLATE
P/N: 4111201



BAG
P/N: 4126701,4113001



USER MANUAL
P/N: 4131201

EZ RAZE SYSTEM COMPONENTS

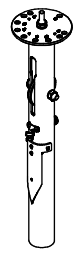

TOP PULLEY/GUY COLLAR TIP
P/N: 4110601

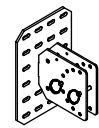

BOLSTER PLATE
P/N: 4130101

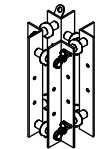

CARRIAGE ASSEMBLY
P/N: 4113702



QT'Y. (2) CUP HOLDER
P/N: 4114101



QT'Y. (2) SIDE BRACKETS
P/N: 4114002

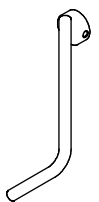

WINCH HANDLE
P/N: 4115301

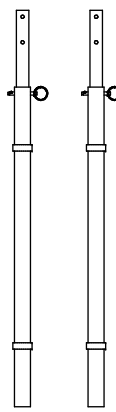

QT'Y. (2) EXTENSION ARMS
P/N: 4114201

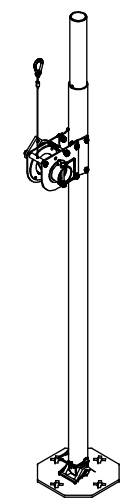

BASE TUBE S/A
P/N: 4164804



AN EMPLOYEE OWNED COMPANY
ORRVILLE, OH

TITLE		
TWR CF 60FT BLK W/EZRAZE SYSTEM		
SIZE	PN:	REV
	714116000	00

4

3

2

1