

TRIPOD
P/N:4110701

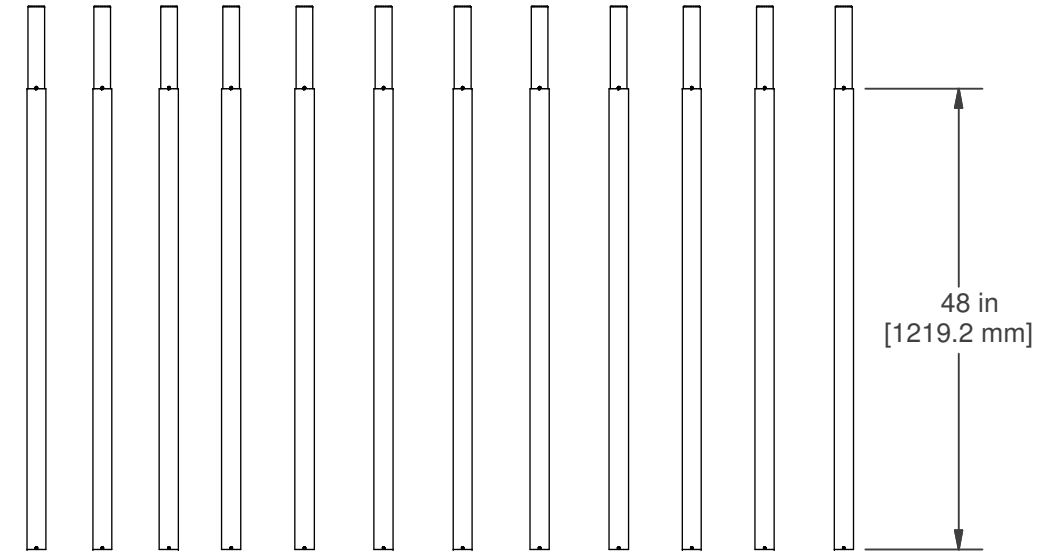

QTY. (12) CF TUBE SECTION
P/N: 4112201

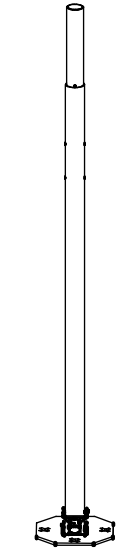

BASE TUBE S/A
P/N: 4164801

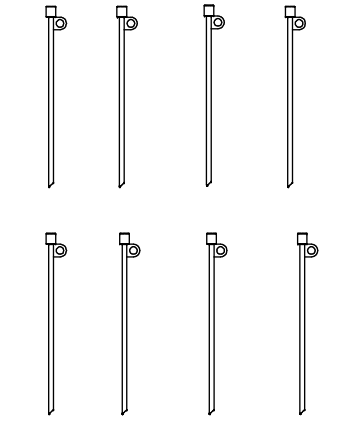

QTY. (8) GUY STAKES
P/N:4109901

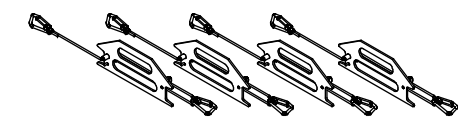

QTY. (4) ROPE STAYS
P/N: 4383101



QTY. (3) BASE PLATE
P/N: 4111201

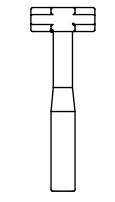

HAMMER
P/N: 4128101

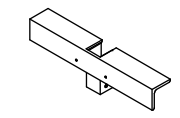

STEP
P/N: 4132101



BAG
P/N: 4126701,4113001

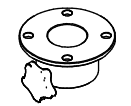

GUY COLLAR
4-WAY
P/N: 4383301



USER MANUAL
P/N: 4131101

		AN EMPLOYEE OWNED COMPANY ORRVILLE, OH	
TITLE TWR CF 52FT BLK			
SIZE	PN:	714015200	REV 00
			SHEET 1 OF 1