

TRIPOD  
P/N:4131501

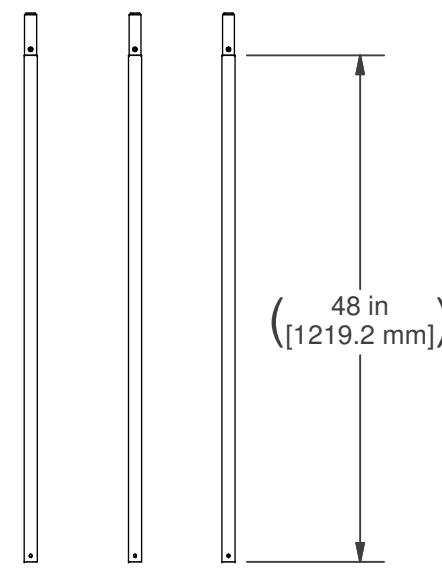

QTY. (3) TUBE SECTION  
P/N: 4120601

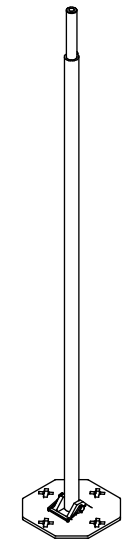

BASE TUBE S/A  
P/N: 4164901

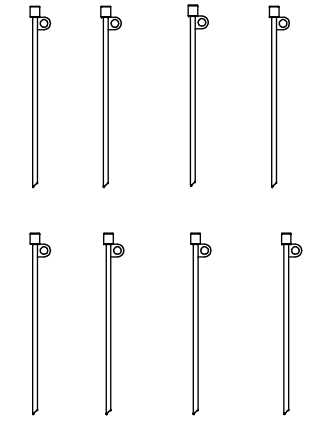

QTY. (8) GUY STAKES  
P/N:4109901

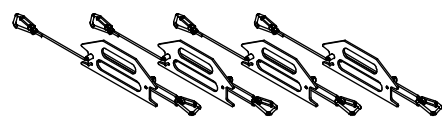

QTY. (4) ROPE STAYS  
P/N: 4247805

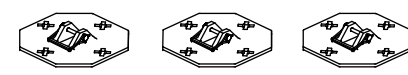

QTY. (3) BASE PLATE  
P/N: 4111201

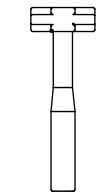

HAMMER  
P/N: 4128101

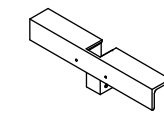

STEP  
P/N: 4132101



BAG  
P/N: 4113001

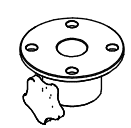

GUY COLLAR  
4-WAY  
P/N: 4383501



USER MANUAL  
P/N: 4131101

		AN EMPLOYEE OWNED COMPANY ORRVILLE, OH	
TITLE <b>TM STL 16FT BLK</b>			
SIZE	PN:	<b>714601600</b>	REV 00
			SHEET 1 OF 1