

TRIPOD
P/N:4131501

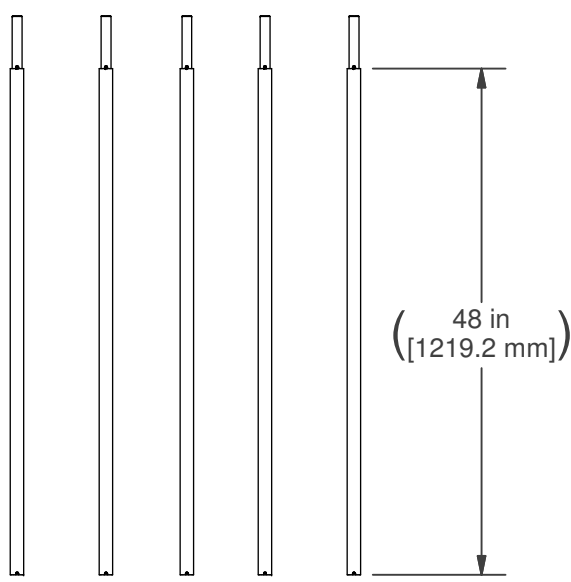

QT'Y. (5) CF TUBE SECTION
P/N: 4132801

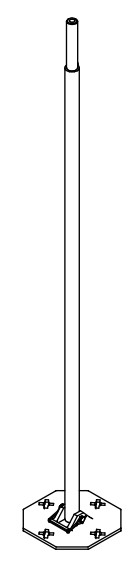

BASE TUBE S/A
P/N: 4164901

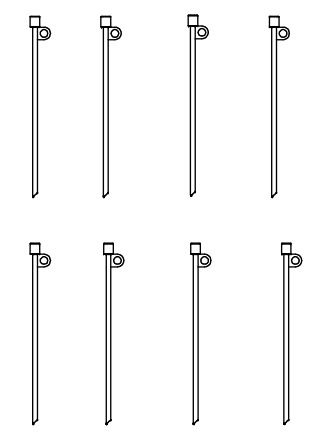

QT'Y. (8) GUY STAKES
P/N:4109901

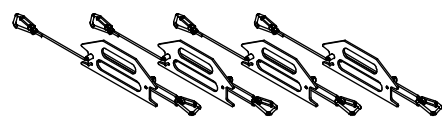

QT'Y. (4) ROPE STAYS
P/N: 4247805



QT'Y. (3) BASE PLATE
P/N: 4111201

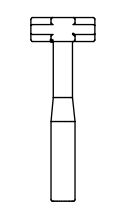

HAMMER
P/N: 4128101

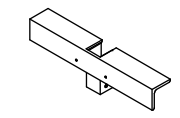

STEP
P/N: 4132101



BAG
P/N: 4113001

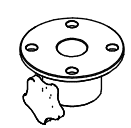

GUY COLLAR
4-WAY
P/N: 4383501



USER MANUAL
P/N: 4131101

		AN EMPLOYEE OWNED COMPANY ORRVILLE, OH	
TITLE MM CF 24FT BLK			
SIZE	PN:	714402400	REV 00
			SHEET 1 OF 1